

BenchPro™

BP-P Postal Bench Scale

Operation Manual



RICE LAKE[®]
WEIGHING SYSTEMS

An ISO 9001 registered company
© Rice Lake Weighing Systems. All rights reserved.

Rice Lake Weighing Systems® is a registered trademark of
Rice Lake Weighing Systems.

All other brand or product names within this publication are trademarks or
registered trademarks of their respective companies.

All information contained within this publication is, to the best of our knowledge, complete and
accurate at the time of publication. Rice Lake Weighing Systems reserves the right to make
changes to the technology, features, specifications and design of the equipment without notice.

The most current version of this publication, software, firmware and all other product
updates can be found on our website:

www.ricelake.com

Contents

1.0	Introduction	1
1.1	Safety	1
2.0	Setup	2
2.1	Unpacking the Scale	2
2.2	Scale Setup	2
2.2.1	Display Mounting	2
2.3	Power	3
2.4	Connections	3
3.0	Operation	4
3.1	Keys and Symbols	4
3.1.1	Initial Power Up	5
3.1.2	Weigh Mode	5
3.1.3	Tare	5
4.0	Configuration	6
4.1	User Menu	6
4.2	Service Menu	7
4.2.1	Access Service Menu	7
4.2.2	Configure Service Parameters	8
4.3	Gravity Mode Setting	10
5.0	Calibration	11
5.1	Span Calibration	11
5.2	Linear Calibration	12
6.0	Communication	14
6.1	Scale to Computer Port Connections	14
6.2	I/O Specifications	14
6.3	USB	15
6.4	Interface Protocols	16
6.4.1	NCI General Serial Communications Protocol	16
6.4.2	SMA Interface Protocol	18
6.5	Sealing Scale for Weights and Measures	21
6.5.1	Seal Scale	21
7.0	Maintenance and Troubleshooting	22
7.1	Troubleshooting	22
7.1.1	Diagnostics Menu	22
7.1.2	Power Troubleshooting	22
7.2	Load Cell Wiring	22
8.0	Compliance	23
9.0	Specifications	24
9.1	Dimensions	25
9.1.1	BenchPro Postal	25
9.2	Options	25
9.2.1	Column Bracket and Post Option (PN 174783)	25
9.2.2	Tabletop Display Post Option (PN 183103)	26
9.2.3	Customer Display Option (PN 180901)	26
9.2.4	Second Operator Display Option (PN 174784)	26



Technical training seminars are available through Rice Lake Weighing Systems. Course descriptions and dates can be viewed at www.ricelake.com/training or obtained by calling 715-234-9171 and asking for the training department.



Rice Lake continually offers web-based video training on a growing selection of product-related topics at no cost. Visit www.ricelake.com/webinars

1.0 Introduction

This manual provides information needed to set up and use the BenchPro™ Postal scale.



Manuals and additional resources are available from the Rice Lake Weighing Systems website at www.ricelake.com
Warranty information can be found on the website at www.ricelake.com/warranties

1.1 Safety

Safety Signal Definitions:



DANGER Indicates an imminently hazardous situation that, if not avoided, will result in death or serious injury. Includes hazards that are exposed when guards are removed.



WARNING Indicates a potentially hazardous situation that, if not avoided, could result in serious injury or death. Includes hazards that are exposed when guards are removed.



CAUTION Indicates a potentially hazardous situation that, if not avoided, could result in minor or moderate injury.



IMPORTANT Indicates information about procedures that, if not observed, could result in damage to equipment or corruption to and loss of data.

General Safety



Do not operate or work on this equipment unless this manual has been read and all instructions are understood. Failure to follow the instructions or heed the warnings could result in injury or death. Contact any Rice Lake Weighing Systems dealer for replacement manuals.



Failure to heed could result in serious injury or death.

Ensure every individual operating or working with this unit has read and understands the following safety information.

Do not allow minors (children) or inexperienced persons to operate this scale.

Prior to cleaning, make sure the scale is disconnected from the power source.

Do not use this product if any of the components are loose or cracked.

Do not use in the presence of flammable materials.

Operating at voltages and frequencies other than specified could damage the equipment.

Do not use near water and avoid contact with excessive moisture.

Do not drop the scale or subject it to violent shocks.

Do not make alterations or modifications to the scale.

For accurate weighing, the scale must be placed on a stable, level surface.

2.0 Setup

This section provides information regarding the setup of the BenchPro Postal scale.

2.1 Unpacking the Scale

Remove all contents from the packaging. Inspect contents for damage. Contact Rice Lake Weighing Systems and the shipper immediately if items are damaged. Each carton contains the following:

- Scale with operator display attached
- In-line power supply
- U.S. power cord (three-prong AC power adapter)
- USB cable
- RS-232 cable
- Stainless steel weigh platter

2.2 Scale Setup

1. Remove the protective cover from the weigh platter.
2. Place the scale on a sturdy, level surface near a power outlet. Ensure the scale and weigh platter are clear of obstructions.
3. Level the scale by adjusting the leveling feet until the bubble level (under the weigh platter) is within the circle.
4. Tighten the jam nuts on the feet of the scale, once the scale is level.

2.2.1 Display Mounting

A display mount is included with each scale and comes assembled to the scale's die-cast base housing. The included operator display uses two magnets to attach to the mount during use. The display mount can be detached from the scale and mounted to a table or on a wall.

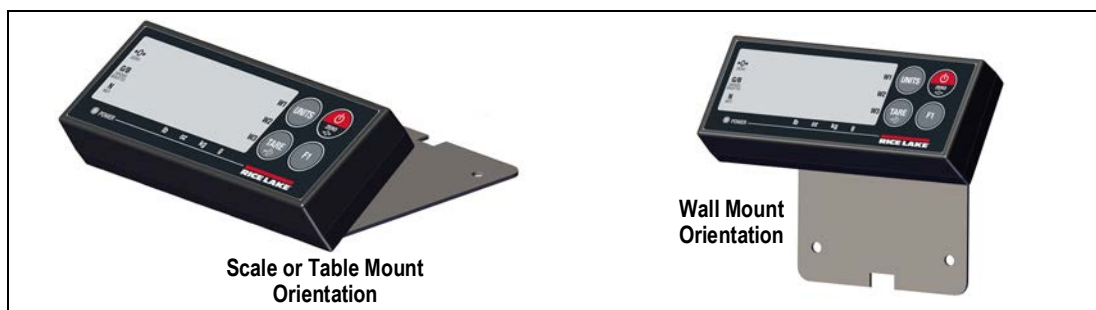

Figure 2-1. Display Mount Configurations

2.3 Power

Power the unit with one of the following sources:

- AC power supply
- USB HID 2.0 powered communications port (can be used as a stand alone device or interfaced to a third-party software program which recognizes devices following USB HID requirements)
- Four AA alkaline batteries (not included)

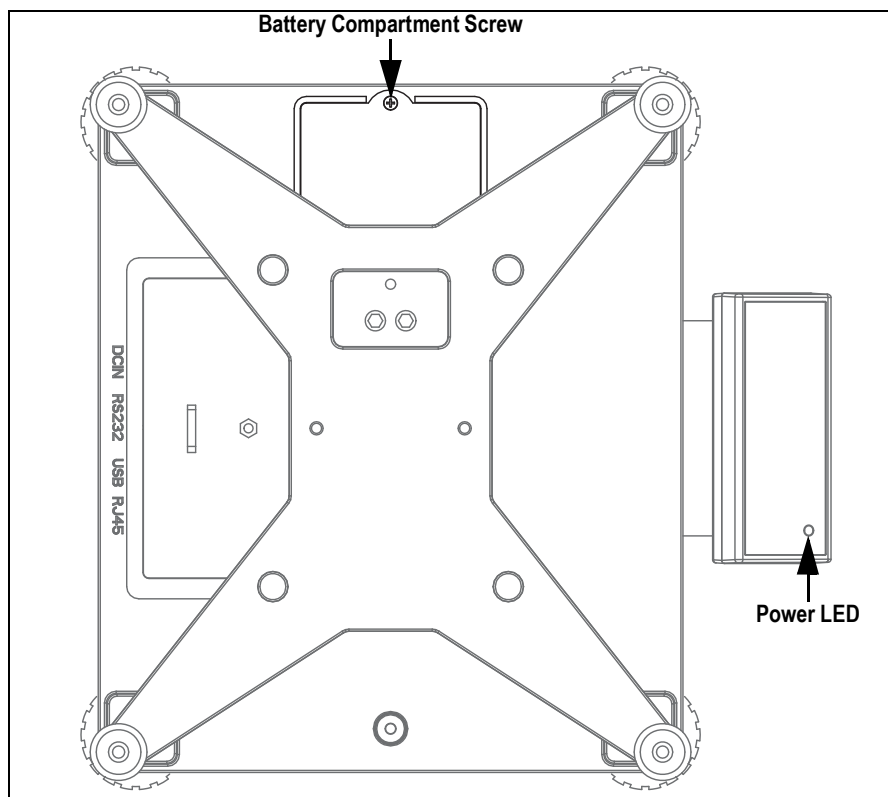



Figure 2-2. BP-P Top View with Weigh Platter Removed

Once the scale is connected to a power source, the power LED illuminates. Press  to power on the scale.

2.4 Connections

The USB connection can be used as an HID device or USB power supply. The scale is equipped with a standard bi-directional RS-232 port for connection to a PC.

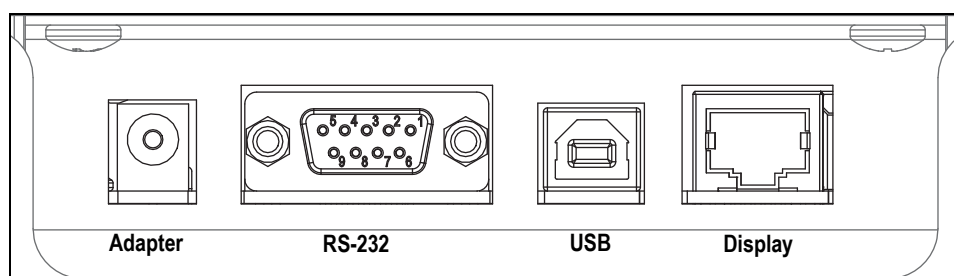

Figure 2-3. Junction Box Connections – Back Of Unit

3.0 Operation

This section provides information regarding the operation of the BenchPro Postal scale.

3.1 Keys and Symbols

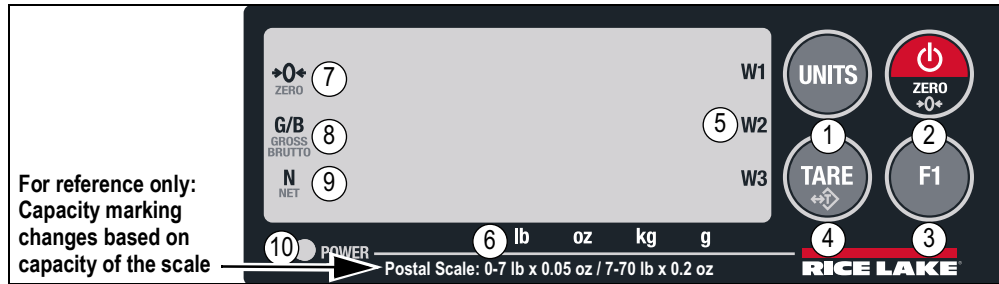

Figure 3-1. Operator Display

Item No.	Key	Description
1		Units Button – Toggle between configured weight units; Enter or accept the value selected
2		Power/Zero Button – Quick press to turn the unit on <ul style="list-style-type: none"> • Press and hold for three seconds to turn the unit off • Perform a zero function
3		F1 Button – Press F1 and Units to enter the user menu and non Legal for Trade configuration parameters of the scale (Section 4.1 on page 6); Used as Print (if enabled); Press to Scroll right
4		Tare Button – Perform a tare function (if enabled); Press Scroll left NOTE: Enabling tare could violate metrological approvals.

Table 3-1. Display Key and Annunciator Functions

Item No.	Description
5	Model dependent: <ul style="list-style-type: none"> • lb/oz scale is dual range and utilizes W1 and W2 • kg scale is triple range and utilizes W1, W2 and W3 The annunciator is showing which range/resolution is used for weighment
6	Units of Measure – Indicates the unit of measure the scale is displaying
7	Stable Zero – Indicates the scale is at a stable zero weight value
8	Gross/Brutto – Indicates the scale is in gross mode
9	Net – Indicates a tare condition and the net weight is displayed
10	Power LED – Indicates scale is receiving power

Table 3-2. Display Key and Annunciator Functions



Figure 3-2. Bench Pro Postal Unit Measurement Ranges

3.1.1 Initial Power Up

Press  to power on the scale.

Upon initial power up, the scale briefly displays the following:

- *P05E* (type of firmware installed)
- Software version number

PASS





Note See [Section 7.1 on page 22](#) if another message other than *PASS* displays during startup.

3.1.2 Weigh Mode

1. Ensure the scale is at zero prior to placing an item on the scale.
2. If the scale is not at zero weight, press . $\rightarrow 0 \leftarrow$ indicates the scale is at a stable zero.

3.1.3 Tare

Tare function must be enabled in the configuration menu for the tare key to be functional. The factory default setting is disabled.

1. Place an item or empty container on the scale. The weight value displays.
2. Press . The weight value displays as zero and **N** displays to indicate the scale is displaying the net weight.
3. Remove the item or container from the scale platform and press  to return the scale to the gross mode. The weight value is zero and **G/B** displays, indicating the scale has returned to the Gross/Brutto mode.



Note *Enabling tare could violate metrological approvals.*





4.0 Configuration

This section provides information regarding the configuration of the BenchPro Postal scale.

4.1 User Menu

The user menu provides the configuration settings for non Legal for Trade parameters.

To enter the user settings menu:

1. Press  and  at the same time
2. To navigate the user settings menu:
3. Press  to scroll through the parameters and settings
4. Press  to accept the value selected
5. Once all parameters have been set, navigate to the **done** parameter and press  to confirm and save settings



Note

See [Section 4.2.2 on page 8](#) for additional explanation on parameters and settings available.

Parameter	Options	Definition
<i>R. oFF</i>	OFF 1 , OFF 3, OFF 5, OFF 30, OFF	Auto Off Time Setting
<i>bRH L</i>	Auto , OFF, On	Backlight Setting
<i>PrOt</i>	SMA , Auto-1, Auto-2, Print, NCi	Protocol
<i>bRUD</i>	9600 , 19200, 38400, 57600, 1200, 2400, 4800	Baud rate
<i>PAR</i>	8 none , 7 even, 7 odd, 7 none	Parity
<i>StoP</i>	1 , 2	Stop bits
<i>tArE</i>	OFF , On	Tare
<i>d iAG</i>	RAM, ROM, DIV-A, DIV-O	Diagnostics
<i>done</i>	—	Done (exit)

Table 4-1. User Menu Parameters



Note

Default settings in are stated in bold ([Table 4-1](#)).

4.2 Service Menu

The service menu provides the configuration settings for all of the parameters and access to perform calibration.

4.2.1 Access Service Menu

1. Press  to power on the unit.
2. Lift the weigh platter from the scale. ----- displays.
3. Remove the 8 mm hex screw and open the PCB compartment.

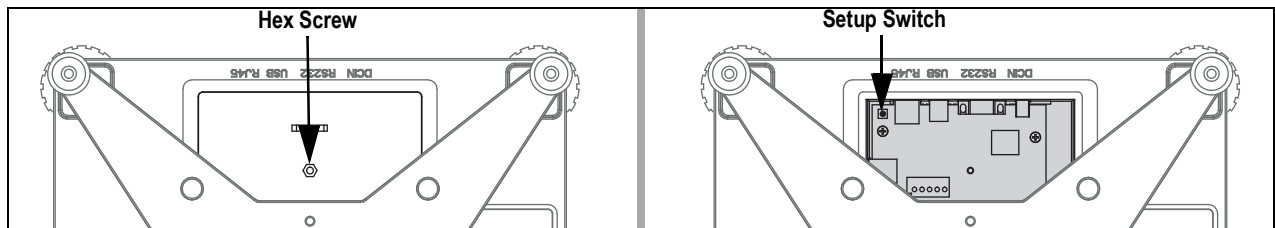



Figure 4-1. BP-P Top View with Weigh Platter Removed

4. Press the Setup Switch.
5. Configure all service parameters ([Section 4.2.2 on page 8](#)).
6. Press  once all parameters have been set **done** displays.
7. Press  to exit and save changes.
8. Set the PCB compartment door back in place and reinstall the hex screw to secure it.
9. Place the weigh platter back onto the scale.

4.2.2 Configure Service Parameters

To navigate the service setting menu:

- Press **F1** to scroll through the parameters and settings
- Press **UNITS** to select a parameter
- Press **TARE** to return to the previous parameter
- Once all parameters have been set, navigate to the **done** parameter and press **UNITS** to confirm and save settings

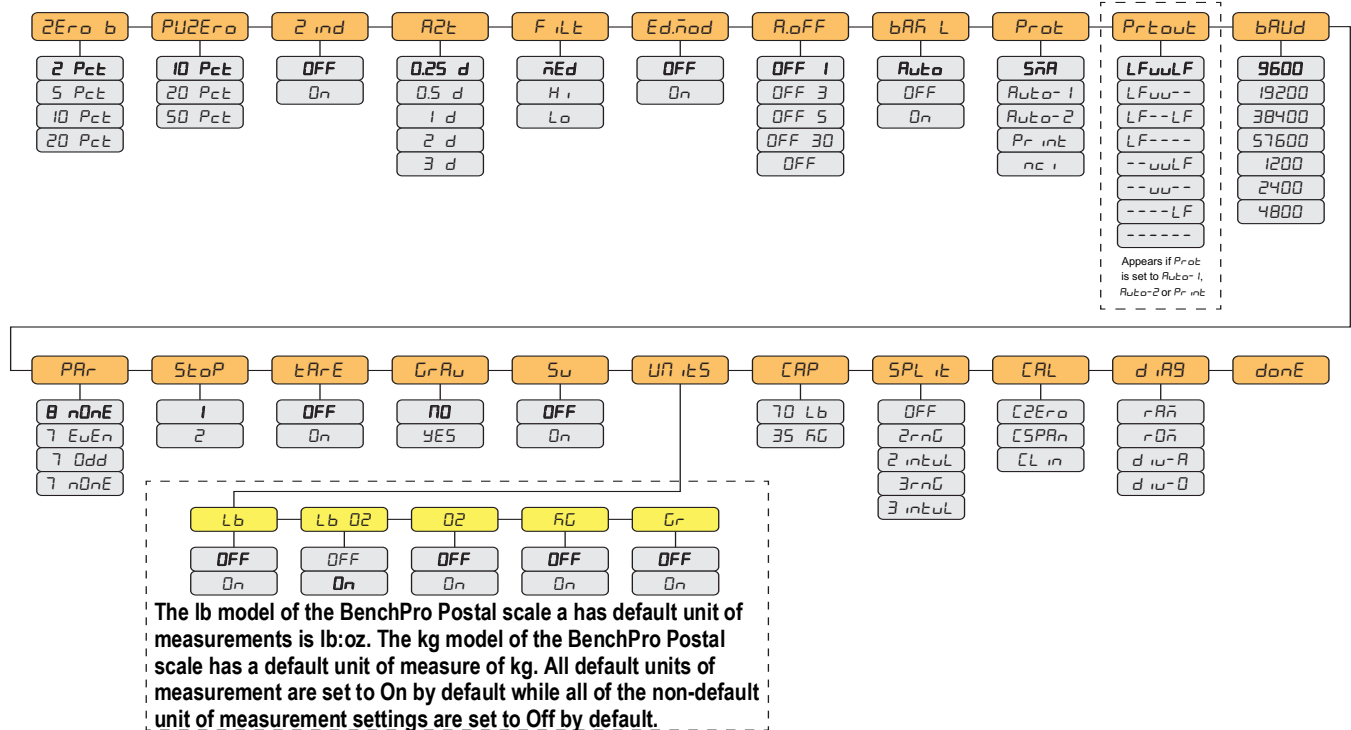

Figure 4-2. Service Menu Parameters

Parameter	Description
ZEROb	Semi Automatic Zero Set – The percentage of the scale capacity which can be zeroed from the scale when the zero key is pressed; Settings: 2%, 5%, 10%, 20%
PUZEro	Initial Power up Zero Setting – The percentage of the scale capacity that can be zeroed from the scale on power up; Settings: 10%, 20%, 50%
Zind	Zero Indication – settings: OFF, ON
AZt	Automatic Zero Tracking – Automatically zeroes the scale if scale does not return to zero; The zero tracking is ± the display division, multiplied by the selected setting, but cannot exceed the semi-automatic zero set; Settings: 0.25 d, 0.5 d, 1 d, 2 d, 3 d
Filt	Filter – Minimizes the effect mechanical vibration (near the scale) can have on scale readings; The selected setting has a direct correlation to the display update rate; Settings: <ul style="list-style-type: none"> • Med - normal filtering, average update rate • Hi - more filtering, slower update rate • Lo - less filtering, faster update rate
Ed. nodE	Manufacturing mode only; Do not use; Do not adjust; Settings: OFF, ON
R. off	Auto Off (only applies to battery powered BP-P 12 x 14 scale) – Select amount of time of inactivity after which scale automatically powers off; Settings: <ul style="list-style-type: none"> • Off 1 – off after 1 minute of no use • Off 3 – off after 3 minutes of no use • Off 5 – off after 5 minutes of no use • Off 30 – off after 30 seconds of no use • Off – scale does not turn off NOTE: tArE configured earlier.

Table 4-2. Service Menu Parameter Settings

Parameter	Description																																																												
bRH L	Backlight Shutdown (only applies to battery powered BP-P 12 x 14 scale) – Conserves battery life; Select the amount of time of inactivity after which the backlight shuts off; Settings: <ul style="list-style-type: none"> AUTO – off after 5 seconds no activity OFF – always off ON – always on 																																																												
Prot	Protocol – Determines manufacturer output protocol or serial setting the scale is configured for; Check third party software to confirm correct selection; Settings: <ul style="list-style-type: none"> SMA – Interface Protocol (Section 6.4.2 on page 18) Auto-1 – Automatically transmit after stable weight above zero is removed from the scale platform Auto-2 – Automatically transmit when the item is placed on the scale and the weight stabilizes Print – Weight is transmitted only when the F1 button on the display panel is pressed NCI – General Serial Communications Protocol (782X and 76XX family) (Section 6.4.1 on page 16) NOTE: If the scale is connected to a PC via the BenchPro USB port, the USB HID protocol is automatically selected; USB HID settings are 1C19,0002.																																																												
PrintOut	Print Out – displays if Prot is set to Auto-1, Auto-2 or Print <table border="1" style="margin: 10px auto; width: 80%;"> <thead> <tr> <th colspan="6">Output Data String Settings</th> </tr> <tr> <th>Setting</th> <th colspan="5">Formatted Output Data String</th> </tr> </thead> <tbody> <tr> <td>LFuuLF</td> <td><LF></td> <td>WWW.WW</td> <td>uu</td> <td><CR></td> <td><LF></td> </tr> <tr> <td>LFuu--</td> <td><LF></td> <td>WWW.WW</td> <td>uu</td> <td><CR></td> <td>--</td> </tr> <tr> <td>LF--LF</td> <td><LF></td> <td>WWW.WW</td> <td>--</td> <td><CR></td> <td><LF></td> </tr> <tr> <td>LF----</td> <td><LF></td> <td>WWW.WW</td> <td>--</td> <td><CR></td> <td>--</td> </tr> <tr> <td>--uuLF</td> <td>--</td> <td>WWW.WW</td> <td>uu</td> <td><CR></td> <td><LF></td> </tr> <tr> <td>--uu--</td> <td>--</td> <td>WWW.WW</td> <td>uu</td> <td><CR></td> <td>--</td> </tr> <tr> <td>---LF</td> <td>--</td> <td>WWW.WW</td> <td>--</td> <td><CR></td> <td><LF></td> </tr> <tr> <td>-----</td> <td>--</td> <td>WWW.WW</td> <td>--</td> <td><CR></td> <td>--</td> </tr> </tbody> </table> <p>Where: <LF> represents the line feed character (0A hex) W represents a weight digit character uu represents the unit of measure characters (lb) <CR> represents the carriage return character (0D hex)</p>	Output Data String Settings						Setting	Formatted Output Data String					LFuuLF	<LF>	WWW.WW	uu	<CR>	<LF>	LFuu--	<LF>	WWW.WW	uu	<CR>	--	LF--LF	<LF>	WWW.WW	--	<CR>	<LF>	LF----	<LF>	WWW.WW	--	<CR>	--	--uuLF	--	WWW.WW	uu	<CR>	<LF>	--uu--	--	WWW.WW	uu	<CR>	--	---LF	--	WWW.WW	--	<CR>	<LF>	-----	--	WWW.WW	--	<CR>	--
Output Data String Settings																																																													
Setting	Formatted Output Data String																																																												
LFuuLF	<LF>	WWW.WW	uu	<CR>	<LF>																																																								
LFuu--	<LF>	WWW.WW	uu	<CR>	--																																																								
LF--LF	<LF>	WWW.WW	--	<CR>	<LF>																																																								
LF----	<LF>	WWW.WW	--	<CR>	--																																																								
--uuLF	--	WWW.WW	uu	<CR>	<LF>																																																								
--uu--	--	WWW.WW	uu	<CR>	--																																																								
---LF	--	WWW.WW	--	<CR>	<LF>																																																								
-----	--	WWW.WW	--	<CR>	--																																																								
bRUD	Baud Rate – For RS-232 connection to PC; Settings: 9600 , 19200, 38400, 57600, 1200, 2400, 4800																																																												
PAR	Data Bits and Parity – For RS-232 connection to PC; Settings: 8 none , 7 even, 7 odd, 7 none																																																												
StoP	Stop bits – For RS-232 connection to PC; Settings: 1 , 2																																																												
tRE	Enable or disable the tare button; Settings: OFF , ON; NOTE: Enabling tare could violate metrological approvals.																																																												
GRA	Gravity Compensation – See Section 4.3 on page 10 for detailed information; Settings: <ul style="list-style-type: none"> No – Deactivated, calibrate scale with known accurate calibration weights Yes – View original calibration gravity and modify local gravity settings 																																																												
Su	Manufacturing mode only; Do not use; Do not adjust; Settings: OFF , ON																																																												
Units	Units of Measure – turn on and off units of measure; applicable settings are dependent on the model of scale purchased; most models have a minimum of two units of measure turned on; to avoid incorrect weight being displayed or transmitted to the PC, only have the applicable units of measure turned on; settings: lb, lb:oz , oz, kg, g																																																												
Cap	Capacity – defines the maximum capacity of the scale and determines the weight value to be used: <ul style="list-style-type: none"> When selecting lb, the calibration weight used must be in lb When selecting kg, the calibration weight used must be in kilograms NOTE: Do not select capacities other than those indicated by the manufacturer.																																																												
SPL t	Configures the unit for multi-range or multi-interval on select models; Settings: <ul style="list-style-type: none"> Off – Unit displays in single range, 2rnG, 2intvL, 3rnG, 3intvL Divisions (multi-range) – Follows gross weight and whatever the largest value count-by/display division you reach that is what the scale locks on and uses until the scale goes back to zero and resets; Range uses the W1, W2, W3 annunciators <ul style="list-style-type: none"> kg Triple Range – 0-5kg x 0.001kg, 0-10kg x 0.002kg, 0-35kg x 0.01kg lb/oz Dual Range – 0-7lb x 0.05oz, 0-70lb x 0.2oz Divisions (multi-interval) – Follows net weight and uses the applicable count-by/display division based on the weight on the scale <ul style="list-style-type: none"> kg Triple Interval – 0-5kg x 0.001kg, 5-10kg x 0.002kg, 10-35kg x 0.01kg lb/oz Dual Interval – 0-7lb x 0.05oz, 7-70lb x 0.2oz NOTE: For factory use only.																																																												
Cal	Calibration – See Section 5.0 on page 11 for detailed information NOTE: To exit the calibration (Cal) parameter without saving changes, the unit must be powered off.																																																												
diag	Diagnostic menu – used to troubleshoot scale operation; See Section 7.1 on page 22 for more information; Settings: <ul style="list-style-type: none"> RAM – PPS5 displays if functioning properly; If anything else displays, contact RLWS for a new PCB ROM – PPS5 displays if functioning properly; If anything else displays, contact RLWS for a new PCB div-A – Display internal counts after auto zero tracking div-O – Display internal counts 																																																												
done	Done – exit the configuration menu, save settings and return to weigh mode																																																												

Table 4-2. Service Menu Parameter Settings (Continued)

4.3 Gravity Mode Setting

Gravitational variations may affect the accuracy of the BenchPro scale upon initial installation. The scale includes a feature which allows for adjustment of the gravity setting to the location and reducing the need for an initial calibration pending regulatory requirements in the region.

The BenchPro is a Legal for Trade device. Rice Lake Weighing Systems recommends contacting an authorized scale technician to perform a calibration using certified test weights.

IMPORTANT Gravity compensation must be turned off when calibrating the scale with weights.

The factory default values are:

- Original Calibration Gravity Constant Setting: 9.7951 or 9.8056
- Local Calibration Gravity Constant Setting: 9.8056 (Rice Lake, Wisconsin)



Note

*The original calibration gravity constant is the location the test weights were placed on the scale to calibrate it.
The local calibration gravity constant is the location the scale is to be used.*

To determine the local calibration gravity constant, use the Internet to identify the local latitude and altitude. Type these values into a gravity calculator to determine the local calibration gravity constant. The BenchPro uses four values to the left of the decimal place and it may be necessary to round the values prior to input.

Use the following steps to modify the local gravity (**GRA**) constant setting.

1. See [Section 4.2.1 on page 7](#) to access and configure parameters within the service menu.
2. Press **F1** until **GRA** displays.
3. Press **UNITS** to enter **GRA** parameter. **ND** is the default.
4. Press **F1** to change it to **YES** and then press **UNITS**. The original calibration gravity constant setting displays.
5. Press **UNITS** to accept. The local calibration gravity constant displays.
6. Press **F1** to increase the flashing digit.
7. Press **TARE** to accept the value entered and move to the next digit.
8. Repeat [Step 6](#) and [Step 7](#) until the local calibration gravity constant is complete.
9. Press **UNITS** until **GRA** displays.
10. Press **F1** until **donE** displays.
11. Press **UNITS** to accept and save the setting. The scale returns to weigh mode.

Below are links to websites used to determine local latitude and altitude. Please note these website address's are provided for reference only and may change.

National Geophysical Data Center: www.ngdc.noaa.gov.

Measurement Canada: www.ic.gc.ca.

Map Coordinates: www.mapcoordinates.net/.

Once local latitude and altitude have been determined, use the following link to calculate local gravity:
www.sensorsone.com/local-gravity-calculator/.

IMPORTANT

It is up to the authorized scale dealer to ensure the device is accurate at the intended point of use, especially for Legal for Trade installations.

5.0 Calibration

This section provides information regarding the calibration of the BenchPro Postal scale.

5.1 Span Calibration

The BenchPro allows for calibration with weight values other than max capacity. [Table 5-1](#) displays the alternate calibration weights for each model.

Calibration should only be performed using certified tests weights and performed by the local scale distributor.



Note Turn off Gravity Compensation, see [Section 4.3 on page 10](#) prior to performing a calibration using certified weights. The default capacity (CAP) setting is in lb if using the lb scale, otherwise the default capacity setting is in kg if using kg calibration weights, change the CAP to the appropriate scale capacity of the scale model. The model number of the scale is located on the serial tag on the bottom of the scale.

Model	Scale Capacity	Alternate Calibration Weights
12 x 14	70 kg	20, 50, 70 lb
12 x 14	35 kg	10, 20, 30 kg



Table 5-1. Alternate Calibration Weights

1. See [Section 4.2.1 on page 7](#) to access service menu. **Zero** displays.
2. Press **F1** until **GRA** displays.
3. Press **UNITS** to accept. **YES** or **NO** displays.
4. Press **F1** to scroll to **NO**.
5. Press **UNITS** to accept. **GRA** displays.
6. Press **F1** until **CAP** displays.



Note See [Section 4.3 on page 10](#) to set Gravity Compensation (GRA) values if required.

7. Select the appropriate scale capacity from [Table 5-1](#).
8. Press **F1** to scroll to chosen capacity.
9. Press **UNITS** to accept. **CAP** displays.
10. Press **F1** until **CAL** displays.
11. Press **UNITS** to accept. **Zero** displays.
12. With no weight on the weight platter, press **UNITS** to accept. A six digit value displays.
This is the internal counts of the load cell at zero weight.
13. Press **UNITS** to accept and perform a zero calibration. **Zero** displays.
14. Press **F1** once. **SPAN** displays.
15. Press **UNITS** to accept. XXX lb or XXX kg displays.

16. Press  to scroll to the alternate calibrate weight value, if performing a calibration using certified weights.
17. Press  to accept. \square displays.
18. Place the calibration weight on the scale and wait for the value to stabilize.
19. Press  to accept. The calibration data is saved and the scale returns to the weigh mode.















The weight value displayed must match the value of the calibration weight used. If not, perform the calibration a second time and follow each step carefully. If ERR displays, there is a calibration error. Ensure the correct calibration weight value was selected in comparison to the actual calibration weight used. See [Section 7.1 on page 22](#) for more information on troubleshooting.







5.2 Linear Calibration

IMPORTANT

Only perform a linear calibration function if instructed by Rice Lake Weighing Systems and an authorized scale technician.

The BenchPro includes an optional linear calibration feature. This is an additional feature to perform after a span calibration has been completed at **maximum capacity** and linear calibration is performed with two lower calibration weight values.

1. See [Section 4.2.1 on page 7](#) to access service menu. $Zero$ displays.
2. Press  until GRA displays.
3. Press  to accept. YES or n displays.
4. Press  until n displays.
5. Press  to accept. GRA displays.
6. Press  until CAP displays.
7. Press  to enter CAP parameter.
8. To choose the appropriate scale capacity, see [Table 5-1 on page 11](#).
9. Press  to scroll to chosen capacity.
10. Press  to accept. CAP displays.
11. Press  until CAL displays.
12. Press  to enter CAL parameter. $Zero$ displays.
13. With no weight on the platter, press  to enter $Zero$ parameter. The raw A/D counts for zero displays.
14. Press  to calibrate zero. $Zero$ displays.
15. Press  until Lin displays.
16. Press  to enter Lin parameter. $Point$ briefly displays, followed by the $Point$ weight value.

17. Press  to select the **Po int 1** value (amount of test weight needed on scale for calibration of **Po int 1**).
18. Press  to accept value. **0** displays.
19. Place the **Po int 1** weight on the weigh platter and wait for the value to stabilize.
20. Press  to accept and calibrate at **Po int 1**.
21. **Po int 2** briefly displays, followed by the **Po int 2** weight value. Remove **Po int 1** test weights.
22. Press  to select the **Po int 2** value (amount of test weight needed on scale for calibration of **Po int 2**).
23. Press  to accept value. **0** displays.
24. Place the **Po int 2** calibration weight on the scale and wait for the value to stabilize (the raw A/D counts displays).
25. Press  to accept and calibrate at **Po int 2**. The calibration data is saved and the scale returns to weigh mode.

The weight value displayed must match the value of the calibration weight used. If not, perform the calibration a second time and follow each step carefully. If **Err 1** displays, there is a calibration error. Ensure the correct calibration weight value was selected in comparison to the actual calibration weight used. See [Section 7.1 on page 22](#) for more information on troubleshooting.

6.0 Communication

This section provides information regarding the connection of the BenchPro Postal scale.

6.1 Scale to Computer Port Connections

The BenchPro Postal scale can be connected to a computer using a compatible third party software program. In order for the scale to transmit the weight, identify the interface protocol included in the third party program and compare with the BenchPro Software Compatibility Chart, see [Section 6.3 on page 15](#). The most current version of the compatibility chart can be found on the Rice Lake Weighing Systems website.

Scale Com Port
DB-9 (9-pin) female connector
Powered USB 2.0 COM port (USB HID compatible software only)
DB-9 (9-pin) female connector RS-232/USB converter

Table 6-1. Communication Ports

6.2 I/O Specifications

The unit includes both a straight pass through RS-232 cable and USB Cable. For functional pin information, see [Table 6-2](#):

DB-9 Male Host		
Pin	Name	Direction
1	DCD IN	--
2	RXD	IN
3	TXD	OUT
4	DTR	OUT
5	GRND	--
6	DSR	IN
7	TRS	OUT
8	CTS	IN
9	OUT	OUT

Table 6-2. DB-9 Male Host on Computer

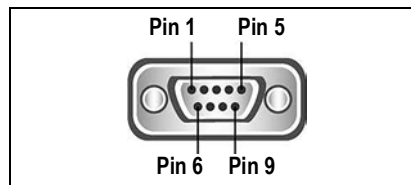

Figure 6-1. RS-232 – 9-Pin Connector

Pin	Name
1	--
2	TXD
3	RXD
4	--
5	GRND
6	--
7	CRS
8	RTS
9	--

Table 6-3. RS-232 Pin Out (9-Pin) On Scale



Note Modem control lines are not supported. The scale is DTE.

6.3 USB

The BenchPro Postal scales conform to the USB HID Point of Sale Usage Tables, March 5 2001, Version 1.02. Reference www.usb.org, HID Information at www.usb.org/hid

Make sure the computer software has a USB HID scale interface. After plugging into the USB port, turn the scale on. The following is displayed.

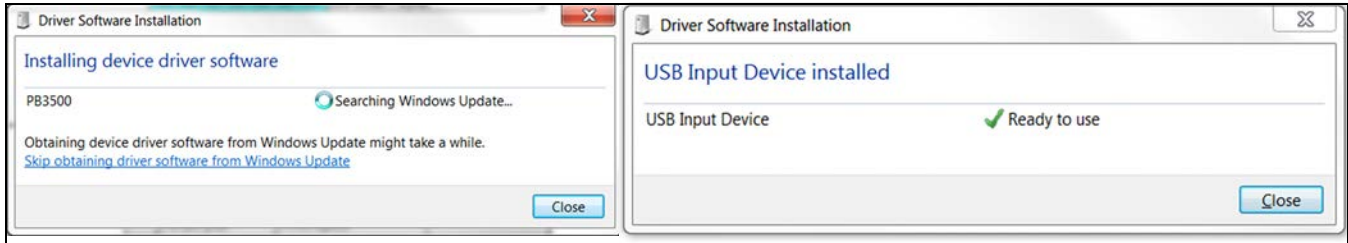

Figure 6-2. USB Driver Install

When the driver is installed, using Device Manager, the BenchPro will be identified as a HID-compliant device.

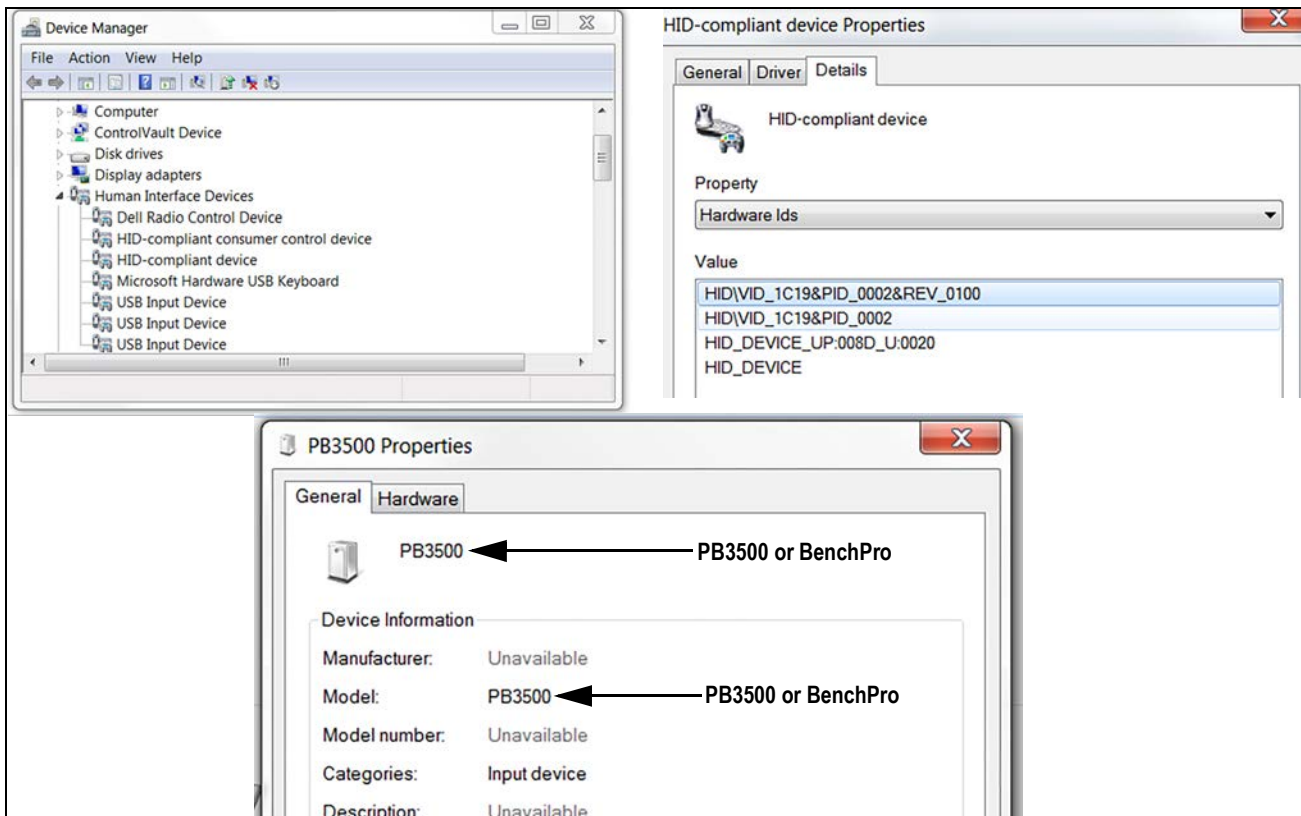

Figure 6-3. Device Properties

Once the Windows® driver has been found, the device is ready for use.

USB Specs

- Vendor ID = 1C19
- Product ID = 0002

Model Interface Protocols

- SMA, Auto-1, Auto-2, Print, NCI, USB Hid (USB port only)

6.4 Interface Protocols

6.4.1 NCI General Serial Communications Protocol

Command	W<CR> (57h,0dh)																				
Over capacity (invalid data)	<LF>	^	^	^	^	^	^	^	^	<U>	<U>	<CR>	<LF>	<H1>	<H2>	<CR>	<ETX>	>			
Under capacity (-20d)	<LF>	-	-	-	-	-	-	-	-	<U>	<U>	<CR>	<LF>	<H1>	<H2>	<CR>	<ETX>	>			
Zero point error (Initial Zero)	<LF>	-	-	-	-	-	-	-	-	<U>	<U>	<CR>	<LF>	<H1>	<H2>	<CR>	<ETX>	>			
In lb/oz/kg/g (normal data)	<LF>	<p>	<W>	.	<W>	<W>	<W>	<W>	<U>	<U>	<CR>	<LF>	<H1>	<H2>	<CR>	<ETX>	>				
In lb/oz/kg/g	<LF>	<p>	<W>	<W>	.	<W>	<W>	<W>	<U>	<U>	<CR>	<LF>	<H1>	<H2>	<CR>	<ETX>	>				
In lb/oz/kg/g	<LF>	<p>	<W>	<W>	<W>	.	<W>	<W>	<U>	<U>	<CR>	<LF>	<H1>	<H2>	<CR>	<ETX>	>				
In lb/oz/kg/g	<LF>	<p>	<W>	<W>	<W>	<W>	.	<W>	<U>	<U>	<CR>	<LF>	<H1>	<H2>	<CR>	<ETX>	>				
In lb/oz/kg/g	<LF>	<p>	<sp>	<W>	<W>	<W>	<W>	<W>	<U>	<U>	<CR>	<LF>	<H1>	<H2>	<CR>	<ETX>	>				
In lb:oz	<LF>	<p>	<W>	l	b	<sp>	<W>	<W>	.	<W>	<W>	o	z	<CR>	<LF>	<H1>	<H2>	<CR>	<ETX>	>	
In lb:oz	<LF>	<p>	<W>	<W>	l	b	<sp>	<W>	<W>	.	<W>	<W>	o	z	<CR>	<LF>	<H1>	<H2>	<CR>	<ETX>	>
In lb:oz	<LF>	<p>	<sp>	<W>	<W>	<W>	l	b	<sp>	<W>	<W>	o	z	<CR>	<LF>	<H1>	<H2>	<CR>	<ETX>	>	

Table 6-4. Request Displayed Weight

Command	H<CR> (48h,0dh)																					
Over Capacity (Invalid Data)	<LF>	>	^	^	^	^	^	^	^	<U>	<U>	<CR>	<LF>	<H1>	<H2>	<CR>	<ETX>	>				
Under Capacity	<LF>	>	-	-	-	-	-	-	-	<U>	<U>	<CR>	<LF>	<H1>	<H2>	<CR>	<ETX>	>				
Zero Point Error	<LF>	>	-	-	-	-	-	-	-	<U>	<U>	<CR>	<LF>	<H1>	<H2>	<CR>	<ETX>	>				
In lb/oz/kg/g (Normal Data)	<LF>	>	<p>	<W>	.	<W>	<W>	<W>	<W>	<U>	<U>	<CR>	<LF>	<H1>	<H2>	<CR>	<ETX>	>				
In lb/oz/kg/g	<LF>	>	<p>	<W>	<W>	.	<W>	<W>	<W>	<U>	<U>	<CR>	<LF>	<H1>	<H2>	<CR>	<ETX>	>				
In lb/oz/kg/g	<LF>	>	<p>	<W>	<W>	<W>	.	<W>	<W>	<U>	<U>	<CR>	<LF>	<H1>	<H2>	<CR>	<ETX>	>				
In lb/oz/kg/g	<LF>	>	<p>	<W>	<W>	<W>	<W>	.	<W>	<U>	<U>	<CR>	<LF>	<H1>	<H2>	<CR>	<ETX>	>				
In lb/oz/kg/g	<LF>	>	<p>	<W>	<W>	<W>	<W>	.	<W>	<U>	<U>	<CR>	<LF>	<H1>	<H2>	<CR>	<ETX>	>				
In lb:oz	<LF>	>	<p>	<W>	l	b	<sp>	<W>	<W>	.	<W>	<W>	o	z	<CR>	<LF>	<H1>	<H2>	<CR>	<ETX>	>	
In lb:oz	<LF>	>	<p>	<W>	<W>	l	b	<sp>	<W>	<W>	.	<W>	<W>	o	z	<CR>	<LF>	<H1>	<H2>	<CR>	<ETX>	>
In lb:oz	<LF>	>	<p>	<W>	<W>	l	b	<sp>	<W>	<W>	.	<W>	<W>	o	z	<CR>	<LF>	<H1>	<H2>	<CR>	<ETX>	>
In lb:oz	<LF>	>	<p>	<sp>	<W>	<W>	<W>	<W>	l	b	<sp>	<W>	<W>	o	z	<CR>	<LF>	<H1>	<H2>	<CR>	<ETX>	>

Table 6-5. Request High-Resolution Weight (10x)

Command	M<CR> (4dh,0dh)															
Raw Count	<LF>	<M>	<M>	<M>	<M>	<M>	<M>	<M>	M	M	<CR>	<LF>	<H1>	<H2>	<CR>	<ETX>

Table 6-6. Request Displayed Raw Count

Command	S<CR> (53h,0dh)				
Response	<LF>	<H1>	<H2>	<CR>	<ETX>

Table 6-7. Request Current Status

Command	Z<CR> (5ah,0dh)				
Simulate ZERO Key	<LF>	<H1>	<H2>	<CR>	<ETX>

Table 6-8. Request Scale to Zero

Command	T<CR> (54h,0dh)				
Simulate TARE Key	<LF>	<H1>	<H2>	<CR>	<ETX>

Table 6-9. Request Scale to Tare

Command	X<CR> (58h,0dh)				
Simulate OFF key	x	x	x	x	x

Table 6-11. Power Off the Scale

Command	Others (xxh,0dh)				
Response	<LF>	?	<CR>	<ETX>	

Table 6-12. Unrecognized Command

Command	U<CR> (55h,0dh)											
Simulate UNIT key (lb/kg)	<LF>	<U>	<U>	<CR>	<LF>	<H1>	<H2>	<CR>	<ETX>			
Simulate UNIT key (lb:oz)	<LF>	l	b	:	o	z	<CR>	<LF>	<H1>	<H2>	<CR>	<ETX>

Table 6-10. Change Units of Measure

Symbol	Description
<LF>	Line feed (0Ah)
<CR>	Carriage return (0Dh)
<ETX>	End of text (03h)
<sp>	Space (20h)
<p>	Polarity "-" or "" (2Dh or 20h)
<U><U>	Measure units "lb","oz","kg","g"
<W><W><W><W><W>	Weight data 5 ~ 6 Bytes
<H1><H2>	Current status
<M><M><M><M><M><M><M>	Raw count 7 Bytes

Table 6-13. Symbols Used

Bit	Byte 1 (H1)	Byte 2 (H2)
0	0=stable	0=not under capacity
	1=not stable	1=under capacity
1	0=not at zero point	0=not over capacity
	1=at zero point	1=over capacity
2	0=RAM ok	0=Flash ROM ok
	1=RAM error	1=Flash ROM error
3	0=eeprom ok	0=calibration ok
	1=eeprom error	1=calibration error
4	Always 1	Always 1
5	Always 1	Always 1
6	Always 0	Always 0
7	Parity	Parity

Table 6-14. Bit Definition <H1-H3>

6.4.2 SMA Interface Protocol

Command	<LF>W<CR> (0Ah,57h,0dh)																			
In lb/oz/kg/g (Normal Data)	<LF>	<s>	<r>	<n>	<m>	<f>	<W>	<W>	<W>	<W>	<W>	.	<W>	<W>	<W>	<W>	<U>	<U>	<U>	<CR>
In lb/oz/kg/g	<LF>	<s>	<r>	<n>	<m>	<f>	<W>	<W>	<W>	<W>	<W>	<W>	.	<W>	<W>	<W>	<U>	<U>	<U>	<CR>
In lb/oz/kg/g	<LF>	<s>	<r>	<n>	<m>	<f>	<W>	<W>	<W>	<W>	<W>	<W>	.	<W>	<W>	<W>	<U>	<U>	<U>	<CR>
In lb/oz/kg/g	<LF>	<s>	<r>	<n>	<m>	<f>	<W>	<W>	<W>	<W>	<W>	<W>	.	<W>	<W>	<W>	<U>	<U>	<U>	<CR>
In lb:oz	<LF>	<s>	<r>	<n>	<m>	<f>	<W>	<W>	<W>	<W>	:	<W>	<W>	.	<W>	<W>	<U>	<U>	<U>	<CR>
In lb:oz	<LF>	<s>	<r>	<n>	<m>	<f>	<W>	<W>	<W>	<W>	:	<W>	<W>	.	<W>	<W>	<U>	<U>	<U>	<CR>
In lb:oz	<LF>	<s>	<r>	<n>	<m>	<f>	<W>	<W>	<W>	<W>	<W>	<W>	:	<W>	<W>	<U>	<U>	<U>	<CR>	
<s> = 'Z' or 'O' or 'U'	<LF>	<s>	<r>	<n>	<m>	<f>	-	-	-	-	-	-	-	-	-	-	<U>	<U>	<U>	<CR>

Table 6-15. Request Displayed Weight

Command	<LF>H<CR> (0Ah,48h,0dh)																			
In lb/oz/kg/g (normal data)	<LF>	<s>	<r>	<n>	<m>	<f>	<W>	<W>	<W>	<W>	<W>	.	<W>	<W>	<W>	<W>	<U>	<U>	<U>	<CR>
In lb/oz/kg/g	<LF>	<s>	<r>	<n>	<m>	<f>	<W>	<W>	<W>	<W>	<W>	<W>	.	<W>	<W>	<W>	<U>	<U>	<U>	<CR>
In lb/oz/kg/g	<LF>	<s>	<r>	<n>	<m>	<f>	<W>	<W>	<W>	<W>	<W>	<W>	.	<W>	<W>	<W>	<U>	<U>	<U>	<CR>
In lb/oz/kg/g	<LF>	<s>	<r>	<n>	<m>	<f>	<W>	<W>	<W>	<W>	<W>	<W>	.	<W>	<W>	<W>	<U>	<U>	<U>	<CR>
In lb:oz	<LF>	<s>	<r>	<n>	<m>	<f>	<W>	<W>	<W>	<W>	:	<W>	<W>	.	<W>	<W>	<U>	<U>	<U>	<CR>
In lb:oz	<LF>	<s>	<r>	<n>	<m>	<f>	<W>	<W>	<W>	<W>	:	<W>	<W>	.	<W>	<W>	<U>	<U>	<U>	<CR>
In lb:oz	<LF>	<s>	<r>	<n>	<m>	<f>	<W>	<W>	<W>	<W>	<W>	<W>	:	<W>	<W>	<U>	<U>	<U>	<CR>	
<s> = 'Z' or 'O' or 'U'	<LF>	<s>	<r>	<n>	<m>	<f>	-	-	-	-	-	-	-	-	-	-	<U>	<U>	<U>	<CR>

Table 6-16. Request High-Resolution weight (10x)

Command	<LF>M<CR> (0Ah,4Dh,0dh)																			
Response	<LF>	<s>	<r>	<n>	<m>	<f>	<W>	<W>	<W>	<W>	<W>	<W>	.	<W>	<W>	<W>	<U>	<U>	<U>	<CR>

Table 6-21. Return Tare Weight

Command	<LF>C<CR> (0Ah,43h,0dh)																			
Response	<LF>	<s>	<r>	<n>	<m>	<f>	<W>	<W>	<W>	<W>	<W>	<W>	.	<W>	<W>	<W>	<U>	<U>	<U>	<CR>

Table 6-22. Clear Scale Tare Weight

Command	<LF>U<CR> (0Ah,55h,0dh)																			
Response	<LF>	<s>	<r>	<n>	<m>	<f>	<W>	<W>	<W>	<W>	<W>	<W>	.	<W>	<W>	<W>	<U>	<U>	<U>	<CR>

Table 6-23. Change Units of Measure

Command	<LF>D<CR> (0Ah,44h,0dh)					
Response	<LF>	<r>	<e>	<c>	<m>	<CR>

Table 6-24. Invoke Scale Diagnostics

Command	<LF>A<CR> (0Ah,42h,0dh)																			
Level / Revision	<LF>	S	M	A	?	<y>	<y>	<y>	<y>	<y>	<y>	~	~	~	~	~	~	~	<y>	<CR>

Table 6-25. About Scale First Line

Command	<LF>B<CR> (0Ah,42h,0dh)																			
Step1: Manufacturer	<LF>	M	F	G	?	<y>	<y>	<y>	<y>	<y>	<y>	~	~	~	~	~	~	~	<y>	<CR>
Step2: Product Module	<LF>	M	O	D	?	<y>	<y>	<y>	<y>	<y>	<y>	~	~	~	~	~	~	~	<y>	<CR>
Step3: Software Revision	<LF>	R	E	V	?	<y>	<y>	<y>	<y>	<y>	<y>	~	~	~	~	~	~	~	<y>	<CR>
Step4: Serial Number	<LF>	S	N	<sp>	?	<y>	<y>	<y>	<y>	<y>	<y>	~	~	~	~	~	~	~	<y>	<CR>
Step5: End	<LF>	E	N	D	?	<CR>														

Table 6-26. About Scale First Line Scroll

Symbol	Description
<LF>	Line feed (0Ah)
<CR>	Carriage return (0Dh)
<sp>	Space (20h)
<s>	Z' Center of Zero 'O' Over Capacity 'U' Under Capacity 'E' Zero Error 'I' Initial-Zero Error " " None of the above condition
<r>	Range ('1','2','3') always "1" for single range

Symbol	Description
<n>	G' Gross normal weight 'T' Tare weight 'N' Net normal weight 'g' Gross weight in high-resolution 'n' Net weight in high-resolution
<m>	M' Scale in motion ' ' Scale not in motion
<f>	Future
<U><U><U>	Measure units "lb ", "oz ", "1/o", "kg ", "g"
<W><W><W><W><W><W> <W><W>	Weight data fixed at 10 Bytes
<y><y><y><y><y><y>	Contain 25 characters maximum

Table 6-27. Symbols Used

Command	<LF>I<CR> (0Ah,49h,0dh)																			
Level / Revision	<LF>	S	M	A	?	<y>	<y>	<y>	<y>	<y>	<y>	~	~	~	~	~	~	~	<y>	<CR>

Table 6-28. Scale Information

Command	<LF>R<CR> (0Ah,52h,0dh)																			
Response	<LF>	<s>	<r>	<n>	<m>	<f>	<W>	<W>	<W>	<W>	<W>	<W>	.	<W>	<W>	<W>	<U>	<U>	<U>	<CR>

Table 6-29. Repeat Displayed Weight Continuously

Command	<LF>S<CR> (0Ah,53h,0dh)																			
Response	<LF>	<s>	<r>	<n>	<m>	<f>	<W>	<W>	<W>	<W>	<W>	<W>	.	<W>	<W>	<W>	<U>	<U>	<U>	<CR>

Table 6-30. Repeat High-Resolution Weight Continuously

6.5 Sealing Scale for Weights and Measures

Once parameters for the scale have been configured and the scale has been calibrated, see [Section 4.2.2 on page 8](#), the scale must be sealed for Weights and Measures.

6.5.1 Seal Scale

1. Lift the weigh platter from the scale.
2. Guide sealing wire through the drilled hex screw and through the PCB compartment door handle.
3. Seal the wire to secure.

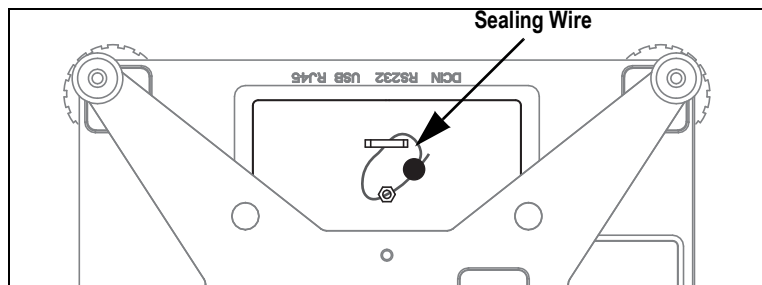

Figure 6-4. Top View with Weigh Platter Removed

7.0 Maintenance and Troubleshooting

Prior to calling customer support, have the software type and software version number available. These are displayed briefly when powering on the scale.

7.1 Troubleshooting

Error Code	Description	Possible Cause	Corrective Action
Err1	Calibration error	Ensure the calibration value selected is equal to the weights being placed on the scale for performing span calibration; damaged load cell	Repeat calibration; Replace load cell
Err2	Power up or initial zero error	Upon power up, weight or item on the platform is greater than <i>PuZEro</i> setting	Remove weight and power cycle the scale
Err3	Semi-auto zero error	When pressing the zero button, the weight value displayed is greater than the % in Zero configuration	--
Err4	Configuration error	Invalid configuration settings	Check configuration settings
Err5	Overload error	Too much weigh applied	Perform calibration, check LC mV
Err6	Memory error	PCB is corrupt	Replace main PCB
LoBAt	Low battery	Battery power voltage is below 4.2 V	Replace batteries
ErrAd	A/D Conversion error	--	Calibrate, replace main PCB
FAL	Failure at initial power up	--	Power cycle the unit by unplugging the power adapter from the outlet or removing the batteries for 30 seconds; Replace the batteries or plug the adapter back in and turn the scale on
--	Scale is weighing properly up to a certain weight but will not weight to full capacity	Overload stop has been tampered with and adjusted too far in	Load scale to 125% of capacity, adjust overload screw so it's touching the bottom of the load cell, back screw off 1/6" of a turn then Loctite in place

Table 7-1. Error Codes

7.1.1 Diagnostics Menu

The diagnostic menu (*d iAG*) is used to troubleshoot scale operation. Use DIV-A or DIV-O to test functionality of the load cell.

1. From the diagnostics menu, press **DIVA** or **DIVO.A** value is displayed.
2. Add weight onto the scale to see if the counts increase.
3. Remove the weight to see if the value returns the value displayed in [Step 1](#).
4. Calibrate the scale before determining a load cell is bad.

7.1.2 Power Troubleshooting

Loss of power to a USB device or intermittent loss of power to the scale causes the scale to turn off. The display may remain at the last display state. Power cycle the scale to reactivate the display.

7.2 Load Cell Wiring

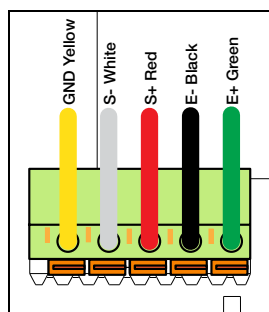

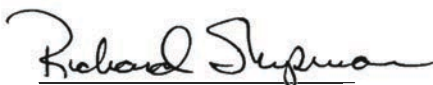

Figure 7-1. Load Cell Wiring

8.0 Compliance

	EU DECLARATION OF CONFORMITY <i>EU-KONFORMITÄTSERKLÄRUNG</i> <i>DÉCLARATION UE DE CONFORMITÉ</i>		Rice Lake Weighing Systems 230 West Coleman Street Rice Lake, Wisconsin 54868 United States of America 
	Type/Typ/Type: BenchPro		
English	We declare under our sole responsibility that the products to which this declaration refers to, is in conformity with the following standard(s) or other regulations document(s).		
Deutsch	Wir erklären unter unserer alleinigen Verantwortung, dass die Produkte auf die sich diese Erklärung bezieht, den folgenden Normen und Regulierungsbestimmungen entsprechen.		
Francais	Nous déclarons sous notre responsabilité que les produits auxquels se rapporte la présente déclaration, sont conformes à la/aux norme/s suivante ou au/aux document/s normatif/s suivant/s.		
EU Directive	Certificates	Standards Used / Notified Body Involvement	
2014/30/EU EMC	-	EN 55024:2010+A1:2015, EN 55032:2015, EN 44032:2012+AC:2013, CISPR 32:2012, EN 61000-3-2:2014, EN 61000-3-3:2013	
2014/35/EU LVD	-	EN 60950-1:2006+A11:2009+A1:2010+A12:2011+A2:2013	
2011/65/EU RoHS	-	EN 50581:2012	
Signature:			Place: <u>Rice Lake, WI USA</u>
Type Name:	<u>Richard Shipman</u>		Date: <u>June 8, 2018</u>
Title:	<u>Quality Manager</u>		

9.0 Specifications

Dynamic Response

Response time for stable weight: 0–1,000 d, 1,000 ms, maximum mean average
1,000 d +, 1,500 ms, maximum mean average

Internal Resolution

500,000 internal count minimum

Overload Protection

Corner and center overload protection

Power

In-line Power Supply (included)

Input	100–240 VAC, +10% -15%, 3-wire w/ground, standard terminated with USA 3-prong plug
Output	12 V at 0.1 Amps DC minimum
Frequency	50/60 Hz \pm 3 Hz, standard
Approvals	UL, CE, EN, CUL

Battery Power

Battery Type	Four AA alkaline batteries, 6 V, with low battery indication at 4.3 volts (not included)
Battery Life	50–250 hours depending on backlight and auto-shutdown settings

USB HID

USB 2.0 max speed; Vendor ID: 1C19; Product ID: 0002

Construction

Powder coat painted mild steel base plate and load bridge with stainless steel weight platter
Die-cast aluminum load bridge and base housing with stainless steel weight platter

Display

Minimum key press life	500,000 cycles, ABS plastic housing
Six annunciators	Zero, Gross/Brutto, Net, W1/W2/W3 multi-range
Four buttons	Units, On/Off, F1 (Tare is not applicable)

RS-232 Cable

10' DB 9-pin male to female, straight pass through and null modem

USB Cable

46" (1,168.4 mm) A/B type USB cable

Approvals:



NTEP COC # 17-002

**Measurement
Canada
Approved**

Canada Weights and Measures: AM - 6050

Warranty

Two-year limited warranty

9.1 Dimensions

9.1.1 BenchPro Postal

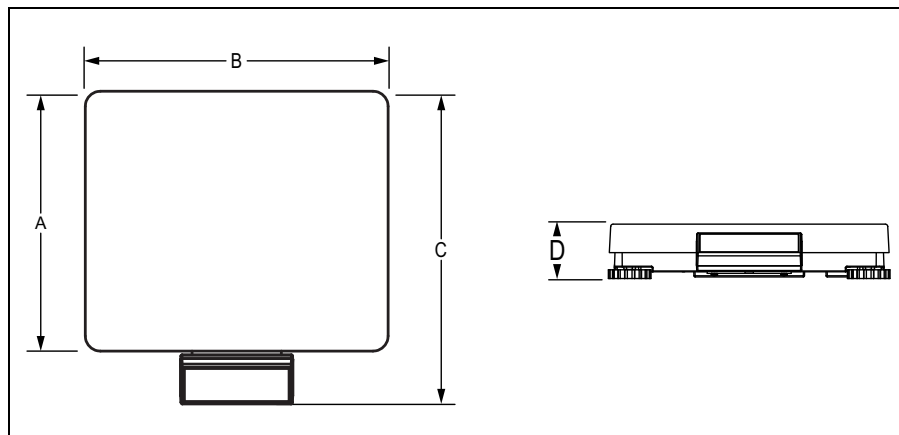

Figure 9-1. Stainless/Mild Steel Scale Dimensions

Model	A	B	C	D
12 x 14	12	14	14.5	2.7

Table 9-1. Stainless/Mild Steel Scale Dimensions (Inches)

9.2 Options

The following options can be purchased for the BenchPro Postal scale.

Part Number	Description
174783	Column bracket and post
180901	Second remote customer display, BenchPro Series with 6' cable and capacity labels
174784	Second remote operator display, BenchPro Series with 6' cable and capacity labels
183103	16" high desktop display mount
178501	USB-RS-232 serial adapter
178501	3.28" cable

Table 9-2. BenchPro Options

9.2.1 Column Bracket and Post Option (PN 174783)

An optional column bracket is available for use with the remote display (not included).



Figure 9-2. Optional Column Bracket and Post

9.2.2 Tabletop Display Post Option (PN 183103)

An optional 16" high desktop display mount post is available for use with the remote display (not included). The mounting post has provisions to secure it to a table or counter using the mounting holes and adequate hardware. The remote display attaches to the mounting bracket using two magnets which are included with each display.

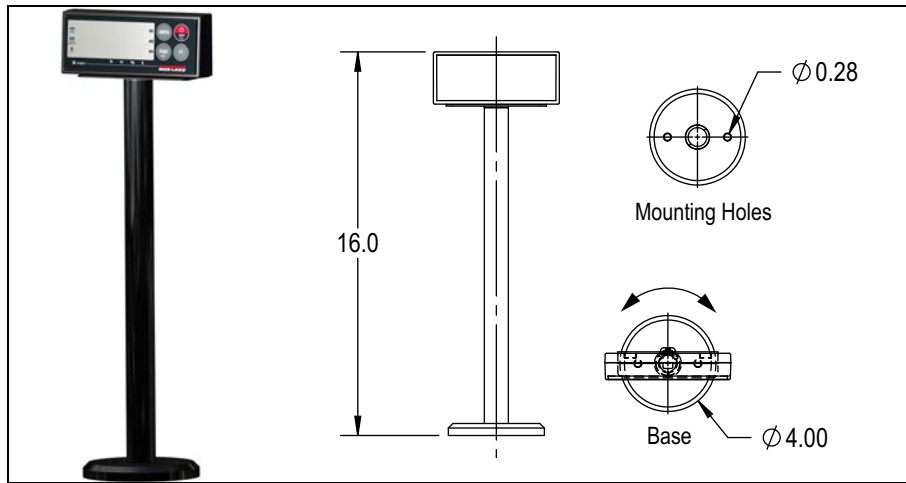
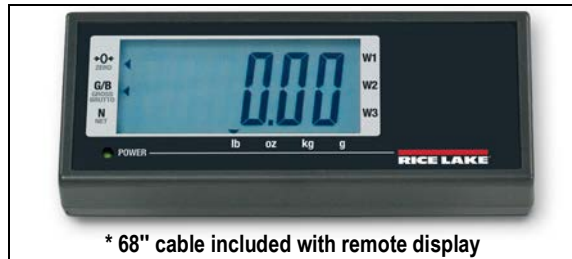

Figure 9-3. Optional Tabletop Display Post

9.2.3 Customer Display Option (PN 180901)



* 68" cable included with remote display

Figure 9-4. Optional Customer Display

9.2.4 Second Operator Display Option (PN 174784)

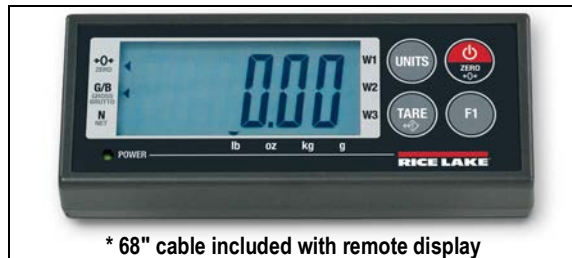

* 68" cable included with remote display

Figure 9-5. Optional Second Operator Display



© Rice Lake Weighing Systems Specifications subject to change without notice.
Rice Lake Weighing Systems is an ISO 9001 registered company.

230 W. Coleman St. • Rice Lake, WI 54868 • USA

U.S. 800-472-6703 • Canada/Mexico 800-321-6703 • International 715-234-9171 • Europe +31 (0)26 472 1319