

# MSI-8000

*RF Remote Display*

## Operation Manual



An ISO 9001 registered company  
© Rice Lake Weighing Systems. All rights reserved.

Rice Lake Weighing Systems® is a registered trademark of  
Rice Lake Weighing Systems.

All other brand or product names within this publication are trademarks or  
registered trademarks of their respective companies.

All information contained within this publication is, to the best of our knowledge, complete and  
accurate at the time of publication. Rice Lake Weighing Systems reserves the right to make  
changes to the technology, features, specifications and design of the equipment without notice.

The most current version of this publication, software, firmware and all other product  
updates can be found on our website:

[www.ricelake.com](http://www.ricelake.com)

# Contents

<b>1.0</b>	<b>Introduction</b>	<b>1</b>
1.1	Safety	1
1.2	Features	2
1.3	Options	2
1.4	Front Panel	3
<b>2.0</b>	<b>Installation</b>	<b>4</b>
2.1	Unpacking	4
2.2	Getting Started	4
2.3	Battery	4
2.3.1	Charging	4
2.3.2	Battery Longevity	5
<b>3.0</b>	<b>Operation</b>	<b>6</b>
3.1	Power	6
3.2	Zero	6
3.3	Tare	6
3.3.1	Tare and Display the Net Load	6
3.3.2	Clear Tare and Revert to Gross Load	6
3.4	Zero and Tare in Multiple Load Cell Systems	7
<b>4.0</b>	<b>Setup</b>	<b>8</b>
4.1	Setup Navigation	8
4.2	Setup Menu	8
4.3	Function Keys	9
4.3.1	Test	9
4.3.2	Total	9
4.3.3	Net/Gross	10
4.3.4	Peak Hold	10
4.3.5	Units	10
4.3.6	Hi-Res	10
4.3.7	Print	11
4.3.8	Total Remote Devices	11
4.4	Auto-Off	11
4.5	Setpoints	12
4.6	Battery Life	13
4.7	Standard	13
4.8	Remote Display Scale Setup	14
4.8.1	Filter Setup	14
4.8.2	Total Mode	15
<b>5.0</b>	<b>Calibration</b>	<b>16</b>
5.1	Calibrating a Scale/Dyna-Link 2	16
5.2	Initial Calibration	16
5.2.1	Routine Calibration	17
5.2.2	C-Cal Calibration	18
5.3	Setup	18
5.3.1	Standard Settings	19
5.4	Reset the Load Cell Calibration	19



Technical training seminars are available through Rice Lake Weighing Systems. Course descriptions and dates can be viewed at [www.ricelake.com/training](http://www.ricelake.com/training) or obtained by calling 715-234-9171 and asking for the training department.

<b>6.0</b>	<b>Communications</b>	<b>20</b>
6.1	Communications Setup	20
6.2	Communications Menu	20
6.2.1	Printer Setup	20
6.2.2	RF Setup	23
6.2.3	Setup Multiple Sensor Network	24
6.2.4	Scan List ID	26
6.3	Communications Port Hardware	26
6.4	Relays	28
6.4.1	Relay Options	28
6.5	Radio Compliance	29
6.5.1	802.15.4	29
6.5.2	Wi-Fi	29
6.5.3	Bluetooth	29
6.5.4	FHSS (Frequency Hopper Spread Spectrum)	29
<b>7.0</b>	<b>Troubleshooting</b>	<b>30</b>
7.1	Error Codes	31
7.2	Service Counters	31
7.3	Mechanical Dimensions	32
7.4	Firmware Update Procedure	32
7.5	Reset the Remote Control	33
<b>8.0</b>	<b>Specifications</b>	<b>34</b>



Rice Lake continually offers web-based video training on a growing selection of product-related topics at no cost. Visit [www.ricelake.com/webinars](http://www.ricelake.com/webinars)

# 1.0 Introduction

The MSI-8000 RF Remote Display makes wireless control easy with the ability to operate weighing systems from a distance. The wireless remote display can be used for viewing MSI ScaleCore-based crane scales and dynamometers, including any RF compatible MSI-3460 Challenger 3, MSI-4260 Port-A-Weigh or MSI-7300 Dyna-Link 2.

It is fully sealed for outdoor use in most ambient conditions and enhances the safety and usability of Rice Lake's Dyna-Link and crane scale systems. The MSI-8000 RF Remote Display uses a rechargeable Lithium Polymer battery, providing up to 24 hours (typical) of continuous use between charges.

This manual is intended for use by qualified technicians responsible for setting up and operating the MSI-8000 RF Remote Display.



Manuals and additional resources are available from the Rice Lake Weighing Systems website at [www.ricelake.com](http://www.ricelake.com)

Warranty information can be found on the website at [www.ricelake.com/warranties](http://www.ricelake.com/warranties)

## 1.1 Safety

### Safety Signal Definitions:



**DANGER** Indicates an imminently hazardous situation that, if not avoided, will result in death or serious injury. Includes hazards that are exposed when guards are removed.



**WARNING** Indicates a potentially hazardous situation that, if not avoided, could result in serious injury or death. Includes hazards that are exposed when guards are removed.



**CAUTION** Indicates a potentially hazardous situation that, if not avoided, could result in minor or moderate injury.



**IMPORTANT** Indicates information about procedures that, if not observed, could result in damage to equipment or corruption to and loss of data.

### General Safety



**Do not operate or work on this equipment unless this manual has been read and all instructions are understood. Failure to follow the instructions or heed the warnings could result in injury or death. Contact any Rice Lake Weighing Systems dealer for replacement manuals.**



**Failure to heed could result in serious injury or death.**

**Do not allow minors (children) or inexperienced persons to operate this unit.**

**Do not stand near the load being lifted as it is a potential falling hazard. Keep a safe distance.**

**Do not use for purposes other than weight taking or dynamic load monitoring.**

**Do not use any load bearing component that is worn beyond 5% of the original dimension.**

**Do not use any associated lifting product if any components of the load train are cracked, deformed, or show signs of fatigue.**

**Do not exceed the rated load limit of the associated Scale/Dynamometer unit, rigging elements, or the lifting structure.**

**Do not allow multi-point contact with the hook, shackle, or lifting eye of the associated Scale/Dynamometer unit.**

**Do not allow high torque on the Scale/Dynamometer unless it is specifically designed for high torque.**

**Do not make alterations or modifications to the unit or associated load bearing devices.**

**Do not remove or obscure warning labels.**

**For guidelines on the safe rigging and loading of overhead scales and dynamometers, read the "MSI Crane Scale Safety and Periodic Maintenance Manual" (available at [www.msiscales.com](http://www.msiscales.com)).**

**Keep hands, feet and loose clothing away from moving parts.**

**There are no user serviceable parts within the MSI-8000 RF Remote Display. Any repairs are to be performed by qualified service personnel only.**

## 1.2 Features

- Meets or exceeds all U.S./International safety and environmental standards
- No license required; Meets U.S./International RF Transmission Laws
- Rechargeable Lithium Polymer battery provides up to 24 hours operation when fully charged
- Automatic Power Off turns the unit off, after a user set time of no activity, to save battery life
- The enclosure is IP65 rated with shock cushioning on the corners
- Six, 1" (25 mm) LCD digits for clear load readings
- Selectable for kg/lb/tons (US Short)/metric tons/kilonewtons
- Automatic or manual weight totalization for loading operations
- Eight setpoints can be set for in-range load/weight value for operator alerts or process control
- ScaleCore technology provides quick and easy firmware updates and calibration setup/backup
- Optional hard-wired link for applications where RF is not allowed

## 1.3 Options

Part No.	Option	Description
149549	Universal 115/230 VAC 50/60 Hz (NA plug standard) battery charger for MSI-8000 RF Remote Display	Battery charger with North American style plug
149550	Universal 115/230 VAC 50/60 Hz (EC plug standard) battery charger for MSI-8000 RF Remote Display	Battery charger with European style plug
150964	Cable Assembly	Serial cable terminated with female DB-9 connector
151095	Audible Alarm	Contact factory for further information
182223	12 V Car Charger Adapter for MSI-8000 RF Remote Display	Battery charger for use in a 12 V vehicle
–	RS-232 serial-output cable	With D-9 connector 13' (4 m)
–	Dual-purpose RS-232 serial communication and battery charging cable assembly	13' (4 m) with charger pigtail; Allows serial output while being powered with charger
–	RS-232 serial-output cable	4 m TPU Jacket, unterminated 13' (4 m)
–	RS-232 serial cable for hardwire connectivity	26' (8 m) connects 8000 to 7300 Dyna-Link
–	RF Remote Modem, RS-232	For direct connection to computers, scoreboards or serial printers
–	RF Remote Modem, RS-485	For direct connection to 485 serial devices
–	RF Remote Modem, USB	For direct connection to computers USB ports
–	RF Remote Gateway	For direct connection to an Ethernet LAN, use with MSI's SCCMP program
–	RF or Hardwired Scoreboard Display	Various digit sizes from 1.2"–8", contact MSI for models available

Table 1-1. Available Options

## 1.4 Front Panel

The MSI-8000 RF Remote Display front panel, keys and annunciators are described below



Figure 1-1. Front Panel

### Key Functions

Item No.	Key	Description
1		The <b>F1</b> key; Programmable to user selectable functions (Section 4.3 on page 9); Default = <b>Off</b> ; Functions as the <b>Enter/Select</b> key in the setup menus
2		The <b>F2</b> key; Programmable to user selectable functions (Section 4.3 on page 9); Default = <b>Off</b> ; Functions as the <b>Scroll</b> key in the setup menus
3		The <b>F3</b> key; Pre-programmed to <b>Print</b> and cannot be changed
4		The <b>Power</b> key; Powers the unit on and off; In <b>Setup</b> mode, it returns the display to the <b>Weigh</b> mode without storing changes
5		The <b>Zero</b> key; Zeros the residual load on a scale; In <b>Setup</b> mode, it stores changes and returns to the prior level
6		The <b>Tare</b> key; Removes current load value and puts the system into <b>Net Weight</b> mode

Table 1-2. Key Functions

### Annunciator Functions

Item No.	Annunciator	Description
7	Center of Zero	Indicates that the scale is within 1/4 d of zero
8	Standstill	Indicates that the load has settled within the motion window (usually $\pm 1$ d); When this is turned off, the scale will not zero, tare or totalize
9	LED Functions	Indicates the current displayed function <i>Example: If F1 blinks, the peak hold reading is captured. If F2 blinks, the Display and Function Test reading is captured.</i>
10	Total	Indicates the RF linked device is displaying the total accumulated weight; Displays only momentarily
	Peak	Indicates the RF linked device is in the <b>Peak Hold</b> mode
	Net	Indicates the RF linked device is in <b>Net Load</b> mode; A tare weight is subtracted from the gross load
	Metric Ton	In conjunction with the Ton annunciator, indicates the RF linked device is displaying metric tons
	Ton	Illuminated, indicates the RF Linked Device is displaying in U.S. Short Tons (1 ton = 2000 lb); When illuminated with <b>M</b> the RF Linked Device is displaying in metric tons (1 metric ton = 1000 kg)
	Kilonewtons	Indicates load display is in kilonewtons
	Kilograms	Indicates load display is in kilograms
	Pound	Indicates load display is in pounds
11	Setpoints	User programmable setpoints for overload warnings; Setpoints 1 and 2 are red high brightness LEDs
12	Multiple Sensors	Number lit indicates the sensor being displayed; If more than one number is lit, sensors are being summed <i>Example: If both numbers 1 and 2 are lit, then the weight displayed equals the sum of sensor 1 and sensor 2.</i>
13	Display Digits	Include six 1" (25 mm) sunlight visible LCD digits
14	Low Battery	Indicates about 10% of battery life remains; Symbol flashes when automatic shutdown is eminent

Table 1-3. Annunciator Functions

## 2.0 Installation

This section provides an overview of the MSI-8000 RF Remote Display installation instructions.

### 2.1 Unpacking

When unpacking the MSI-8000 RF Remote Display, ensure all parts are accounted for and check for any visible damage. If any parts were damaged in shipment, notify Rice Lake Weighing Systems and the shipper immediately. If the MSI-8000 RF Remote Display must be returned, it must be properly packed with sufficient packing materials. When possible, retain the original carton when shipping the unit back. A standard MSI-8000 RF Remote Display is shipped with a battery charger. The charger is universal and will work on AC supplies from 100 VAC–240 VAC.

### 2.2 Getting Started

Fully charge the battery by plugging the charger into the charge port. Depending on the discharge level of the battery this can take up to 6 hours.

The MSI-8000 RF Remote Display is often shipped pre-configured with a compatible sensor unit such as an Dyna-Link 2 or one of the MSI crane scales. If the MSI-8000 RF Remote Display is purchased separately, or is to be used with a different system, the RF transceivers will have to be paired ([Section 4.4 on page 11](#)).

Once RF setup is complete for the MSI-8000 RF Remote Display, the system will automatically connect with a scale/Dyna-Link. It is recommended to do a site survey to identify operating range and usability of the RF Link. Position the scale/Dyna-Link at an average operational height, and try the link at various positions and distances. The range may vary by the rotation of the scale/Dyna-Link, as well as the site and installation variables.

### 2.3 Battery

Power to the MSI-8000 RF Remote Display is supplied by an internal rechargeable lithium polymer battery, which provides up to 24 hours of continuous use between charging.



Figure 2-1. Battery Charger Plug-In

#### 2.3.1 Charging

Each MSI-8000 RF Remote Display is shipped with a charged battery. However, before using the MSI-8000 RF Remote Display, it is advised to charge the battery until the green light shows it is fully charged. When **LOW BATT** first displays, there is approximately two hours of continued operation remaining. When **LOW BATT** starts flashing the batteries are nearly completely drained. For maximum battery life, it is recommended to recharge the battery as soon as **LOW BATT** displays. It is safe to charge the battery at any point in its discharge curve.

If the blue LED is on, the charger is in **Fast Charge** mode, which puts 80% of the charge into the battery within two hours and can be used at this point. However, it is best to fully charge the battery, until the green light displays.

The charge connector is waterproof when connected and screwed in. To maintain IP65 rating, use the supplied plug cover when the connector is not plugged in.



**Note** The AC end of the charger is not waterproof.



## Charger LED Modes

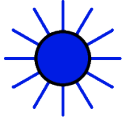

**Blue light** – Indicates a charge is in progress. Charging times vary from one hour to six hours depending on the charge level of the battery when the charger is applied. If the charger is attached as soon as **LOW BATT** displays, charge time will average three hours. It is OK to remove the battery charger while the blue light is on, but a complete charge is recommended.

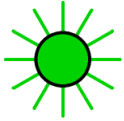

**Green light** – Indicates the battery is fully charged. The powered charger can be left connected to the MSI-8000 RF Remote Display continuously. It is recommended to leave the MSI-8000 RF Remote Display on the charger when not in use.



**Red light** – Indicates a fault. Faults include over temperature, under temperature (the battery must be warmer than 14°F (-10°C)), a severely depleted cell or charge time-out. When the charge times out a trickle charge is applied to the battery. To clear a time-out fault, unplug the charger and then plug it back in. A severely discharged cell may take days on the charger to recover.

### 2.3.2 Battery Longevity

The Lithium Polymer Single Cell Battery used in the MSI-8000 RF Remote Display has a rated number of charges of  $\geq 300$  before capacity starts to degrade. The charging life can be greatly increased by charging the battery more often, and not let it reach the battery cutoff voltage of 3.0 V. The battery voltage can be seen by pressing a function key programmed as **Test**, the battery must be replaced by an Rice Lake certified technician.

#### IMPORTANT

*When the MSI-8000 RF Remote Display is not in use, it is recommended that the charger is left attached to keep a charge.*

*The MSI-8000 RF Remote Display uses a small current when powered off which has the potential to deep discharge the batteries. Never store the MSI-8000 RF Remote Display with a depleted battery. This can cause permanent damage to the battery and require factory replacement. Shelf life of a fully charged battery is about three months.*

## 3.0 Operation

This section provides an overview of the MSI-8000 RF Remote Display operation instructions.

### 3.1 Power

Press  to power the indicator On/Off.



**Note** Ensure the recommended power supply is secured prior to device operation ([Section 2.3 on page 4](#)).

### 3.2 Zero

Sets the zero reading of the scale to remove small deviations in zero when the unit is unloaded.

See [Section 3.3](#) for zeroing (taring) a package, rigging or pallet weights.

Press . The weight must be stable within the motion window for the zero function to work.



**Note** When using multiple scales, ensure the scale to be zeroed displays.  
The backup memory in the unit stores the tare reading, and can restore it even if power fails.

Zero works in Gross or Net mode.

Zeroing while in Net mode will zero the gross load causing the display to show a negative tare value.

The scale must be stable within the motion window and  is lit before it will zero. The scale remembers the zero request for two seconds. If a motion clears in that time, it will zero.

The scale will accept a zero setting over the full range of the scale. Zero settings above 4% of full scale will subtract from the overall capacity of the scale.

Example: If 100 lb is zeroed on a 1000 lb scale/Dyna-Link, the overall capacity of the scale/Dyna-Link will reduce to 900 lb plus the allowed over-range amount.

### 3.3 Tare

Tare is used to zero out a known weight such as rigging, a container or pallet and display the load in **Net** weight.

#### 3.3.1 Tare and Display the Net Load

1. Load the item that needs to be tared onto the scale/Dyna-Link.
2. Press . The weight display changes to 0 and **Net** displays.

#### 3.3.2 Clear Tare and Revert to Gross Load

Press . **Net** turns off indicating the unit is in **Gross** mode.





**Note** Only positive gross load readings can be tared.  
Setting or changing the tare has no effect on the gross zero setting.

Taring will reduce the apparent over range of the scale.

Example: When taring 100 lb of rigging on a 1000 lb scale, the scale will overload at a net load of 900 lb (1000-100) plus any additional allowed overload (usually about 4% or 9 d).

To view the gross load without clearing the tare value, set an **F-key** to Net/Gross ([Section 4.3.3 on page 10](#)).

### 3.4 Zero and Tare in Multiple Load Cell Systems

The channel displayed is considered the **Focus Channel**. Pressing  or  only affects the displayed channel. When displaying summed channels, ZERO or TARE commands are sent to all devices that contribute to the displayed weight.

*Example: In **Both** mode, if pair 1 (sum of SC0 and SC1) displays, pressing  zeros only SC0 and SC1.*

*If displaying the grand total using the **ALL** mode then pressing  will zero all connected sensors.*







*Using the Tare function: If one device is tared in the individual **Display** mode, the summed weight will be the sum of a Net and a Gross weight. If  is pressed when displaying any of the summed modes, all devices that add to the current display are tared and placed in **Net** mode.*

## 4.0 Setup

This section provides an overview of the MSI-8000 RF Remote Display setup instructions.

### 4.1 Setup Navigation

To navigate the menus during setup, follow the information below:

- Press  to enter or select a parameter
- Press  to scroll through the parameters
- To enter a decimal point, press  while the digit is blinking
- Press  to save and go back one level or to **Weigh** mode; *StorE* displays briefly
- If a wrong value is entered, press  to step back one digit and press  to change the digit
- Press  to exit without saving changes

### 4.2 Setup Menu

To enter the setup menu, press  and  simultaneously.

Parameters	Choices	Description
Func 1 Func 2	–	Function Key 1 – Configurable to listed parameters (Section 4.3 on page 9); Default <i>OFF</i>
	–	Function Key 2 – Configurable to listed parameters (Section 4.3 on page 9); Default <i>OFF</i>
	<i>OFF</i>	No function is assigned; The <b>F-key</b> is disabled
	<i>tEst</i>	Test – Runs an LCD test (Section 4.3.1 on page 9)
	<i>totRL</i>	Total – Accumulates multiple weighments (Section 4.3.2 on page 9)
	<i>v-ttL</i>	View Total – Activates the total weight display followed by the number of samples (Section 4.3.2 on page 9)
	<i>nEtGr</i>	Net/Gross – Toggles between <b>Net</b> and <b>Gross</b> modes (Section 4.3.3 on page 10)
	<i>P-HLd</i>	Peak Hold – Automatically updates display when a higher peak weight reading is established (Section 4.3.4 on page 10)
	<i>2Un it</i>	2 Units – Switches the force units between lb and kg (Section 4.3.5 on page 10)
	<i>5Un it</i>	5 Units – Scrolls through all available units: lb, kg, Tons (US Short), metric tons and kilonewtons (Section 4.3.5 on page 10)
	<i>Hi rES</i>	Hi Res – The unit is more sensitive to motion and movement resulting in a less stable display (Section 4.3.6 on page 10)
	<i>Pr int</i>	Print – Outputs a configured text string to the RS-232 port on the base of the Dyna-Link (Section 4.3.7 on page 11)
	<i>tAr-E</i>	Tare – Not used, MSI-8000 RF Remote Display has a dedicated <b>Tare</b> key
	<i>ScAn</i>	Scan – Displays RF connected channels in order
	<i>tL-rd</i>	Total Remote Devices – Displays the summed weight of RF connected sensors (Section 4.3.8 on page 11)
<i>R-OFF</i>	<i>OFF</i> <i>15</i> <i>30</i> <i>45</i> <i>60</i>	Auto Off – Prolongs battery life of the scale by turning power off after the set time (in minutes) that the scale is not in use (Section 4.4 on page 11)
<i>SEtPo intS</i> <i>SEtPt 1-B</i>	<i>GrERt</i> <i>LESS</i> <i>OFF</i>	Greater Than – Setpoint triggers when the tension exceeds the value Less Than – Setpoint triggers when the tension is less than the value Off - Setpoint parameter is disabled
<i>b. L iFE</i>	<i>StAnd</i> <i>LonG</i>	Battery Life – Sets the options for standard or extended battery life (Section 4.6 on page 13)
<i>StAnd</i>	<i>indUS</i> <i>Hb-44</i> <i>r-76</i> <i>Un it</i>	Standards – Sets the industry standard to be used

Table 4-1. Setup Menu Parameter Descriptions

## 4.3 Function Keys

There are two programmable function keys on the MSI-8000 RF Remote Display, **F1** and **F2**.

- Function key setup is independent of the connected scale function keys
- **TARE** and **F3** are standard on the MSI-8000 RF Remote Display and do not need to be programmed
- If a function key does not work, the connected scale may not be set up to support the key

*Example: If F-key is set for **Total**, then **Total** mode setup in the **Setup** menu must also be set up for target scale.*

To set a function key use the following steps:

1. Press **F3** and **ZERO** simultaneously. *Func 1* displays.
2. Press **F2** to scroll to the function key to be programmed.
3. Press **F1**. The currently saved parameter displays.
4. Press **F2** to scroll through the choices.
5. Press **F1** to select the desired choice.
6. Press **ZERO** to save and exit.

### 4.3.1 Test

The test feature only tests the MSI-8000 RF Remote Display. Set an **F-key** to **TEST**.

To run a test, press **Fx-TEST**, the following items scroll across the display.

- Light all LCD segments and the LEDs
- *50Ft* followed by the version number
- *bAtt* followed by the battery level in volts
- *d. tEEt* followed by counting from 00000–99999

The test can be single stepped by:

1. Press **Fx-TEST**, immediately press **F2** to stop the auto scroll.
2. Use **F2** to scroll through the steps and **F1** to view the step value.
3. Press **ZERO** to abort the test at any time.

Internal tests are also performed, if any test fails, an error code displays. See [Section 7.1 on page 31](#) for a description of all error codes.

### 4.3.2 Total

1. Ensure the **Total** mode has been programmed in the setup menu. If this has not been setup the **F-Key** assigned to **Total** will not work.
2. Program an **F-key** to **Total** ([Section 4.3](#)).
3. Press **Fx-Total** to perform the total function that was set in [Section 4.8.2 on page 15](#).

### 4.3.3 Net/Gross

Program an **F-key** to **NetGross** (Section 4.3 on page 9).

Press **Fx-NetGross** to toggle between gross and net (gross minus tare). **Fx-NetGross** only functions if a tare has been established.

The operator can switch back to gross from net without clearing the tare value. Only clearing or setting a new tare will change the tare value held before switching into **Gross** Mode.

### 4.3.4 Peak Hold

**Peak Hold** uses a high speed mode of the A/D converter allowing it to capture transient loads at a far higher rate than typical dynameters.

- Peak Hold is cleared and enabled by pressing **Fx-P-HLd**
- When a new peak is detected, the **Fx** LED flashes three times
- The accuracy of the system in peak hold is slightly reduced to 0.2% of capacity + 5d
- The filter setting is turned off while in **Peak Hold** mode to ensure the fastest acquisition rate

*Example: The Peak Hold function is useful in Dynamic and Fall tests. Common tests include Overall Breaking Strain (OB€), Breaking Force, and Cycled Breaking Strain.*

Capture Peak Force:

1. Program an **F-key** to **P-HLd** (Section 4.3 on page 9).
2. Prepare the stand test and test sample.
3. Press .
4. Press **Fx-P-HLd**, confirm that **Pk** is lit on the display.



**Note** *A small jump in the reading may occur depending on the stability of the test device.*

5. Apply the test weight. The **Fx** LED will blink three times when a new peak ID is detected.
6. Remove the weight and the peak value is recorded.
7. To run a new test, press **Fx-P-HLd** to clear the peak value. Repeat [Step 3–Step 6](#).

### 4.3.5 Units

Program an **F-key** to **Unit** (Section 4.3 on page 9).

Press **Fx-Unit** to set the units parameter to units required for display.

### 4.3.6 Hi-Res



**Note** *Only available with the MSI-7300 Dyna-Link (refer to the Dyna-Link manual PN 152160)*

When set to on, the filter is automatically set to the **Hi-1** setting (if **Hi-2** is already set, then the filter is not changed).

This will have a small effect on settling time. When set to off, the filter setting resets to the previous filter setting.

Program an **F-key** to **HiRes** (Section 4.3 on page 9).



Pressing **Fx-HiRes** places the display into a temporary **High Resolution** mode. This mode continues until **Fx-HiRes** is pressed again, or power is cycled. In the **Hi-Res** mode the appropriate **Fx** LED blinks continuously at a slow rate.





**Note** *Hi-Res mode does not increase the accuracy, but allows for smaller weight incrementation to display.*

Use  or  to zero out any initial error.

### 4.3.7 Print

The **Print** function is set to , so there is no need to program  or  to **Print**.

Pushing  or  on the scale will cause the comm port on the MSI-8000 RF Remote Display to output the selected data string (Section 6.2.1 on page 20).

If an **F-key** is programmed as **Print** and if **Print Setup** is configured as continuous, then  is used for **Start Print/Stop Print**.

### 4.3.8 Total Remote Devices

Sensor summing must be enabled in the communications setup menu. If the **Pairs** or **Both** modes are enabled in the communications setup menu, then pressing **Fx-ttl.rd** will scroll through the available combinations.









**Note** It is common to program  for Scan and  for **ttl.rd** (Total Remote Devices) to allow quick switching between individual channel displays (with Scan) or the summed weight (with **ttl.rd**).

## 4.4 Auto-Off

The **Auto-Off** feature prolongs the battery life by powering off the unit when not in use. When a key is pressed or the detected load is in motion exceeding 10 d, the time limit is reset.

When disabled, the unit will only turn off by pressing , or the battery dies.

To set the **Auto-Off** function:

1. Press  and  simultaneously. **Func 1** displays.
2. Press  to scroll to **A-OFF**.
3. Press . The current auto off time displays.
4. Press  to scroll through the available times.
5. Press  when the desired time displays. **SLEEP** displays.
6. Press  to exit setup and store the settings.

## 4.5 Setpoints

The MSI-8000 RF Remote Display supports eight setpoints. Common uses of setpoints are for warnings or process control. The front panel comes standard with two LED outputs for when setpoints 1 and 2 are triggered.



Figure 4-1. Setpoint LEDs

The MSI-8000 RF Remote Display can have an audible output option installed which is triggered by setpoint 1. Contact Rice Lake Weighing Systems for other setpoint output options.

Setpoint	Description
<b>Setpoint Mode</b>	
OFF	Setpoint is not activated
GRABT	Indicates the setpoint will trigger when the weight exceeds a set value
LESS	Indicates the setpoint will trigger when the weight is less than a set value
<b>Setpoint Weight Type</b>	
NETGR	Responds to net or gross weight
GROSS	Responds to gross weight regardless of the display
TOTAL	Responds to the totaled weight
T-CNT	Responds to the total count (number of samples)
LFcnt	Responds to the number of times the weight has exceeded 25% of capacity

Table 4-2. Available Setpoint Settings

To set the setpoint:

1. Press **F3** and **ZERO** simultaneously. *FUNC 1* displays.
2. Press **F2** to scroll to the desired setpoint (*SETPt 1 - 8*).
3. Press **F1**. The current setpoint mode displays.
4. Press **F2** to scroll to the setpoint mode desired.
5. Press **F1**. The current setpoint weight type displays.
6. Press **F2** to scroll to the desired weight type.
7. Press **F1**. The desired weight type continues to display.
8. Press **F1**. *Sn 1-4* displays.
9. Press **F2** to toggle between *Sn 1-4* and *Sn 5*.
10. With the desired setting displayed, press **F1**. The current weight type value displays.
11. Press **F2** to scroll the numbers and **F1** to enter each digit.



12. When the correct value displays, press . The next setup menu item is displays.



**Note** To enter a decimal point, press  while the digit is blinking. To correct a digit, press  to step back.

13. Press  to exit **Setup** and store the settings.







## 4.6 Battery Life

Select either *StAnd* (Standard Battery Life) or *Long* (Long Battery Life).

In the **Long Battery Life** mode, the system is placed into a sleep state for several seconds at a time if there is no change in tension. This disables the display in order to reduce power consumption and increase battery life. After several seconds, the MSI-8000 RF Remote Display wakes up to check for any changes in tension. If there is a change in tension, the unit stays awake. The unit remains awake if it is in configuration mode.



**Although Long Battery Life mode can significantly increase battery life, performance is better in Standard Battery Life mode.**







1. Press  and  simultaneously. *Funct 1* displays.
2. Press  to scroll to *battery*.
3. Press . The currently saved battery life displays.
4. Press  to toggle between the choices.
5. With choice displayed, press  to select. *StAnd* displays.
6. Press  to save and exit to **Weighing** mode.

## 4.7 Standard

Selection	Description
<i>indUS</i> (Industrial)	This is the most common setting for the MSI-8000 RF Remote Display; With the Industrial standard, there is full range zero, access to units switching, filters, and peak hold
<i>HB-44</i> (Handbook 44)	Enables only approved features per the NTEP HB-44 rules and regulations; Access is denied to <b>Peak Hold</b> , and the zero range may be limited; <b>Filter</b> menu is moved to the <b>Calibration Setup</b> menu, so filters are only accessible through the calibration seal
<i>R-76</i> (R-76)	Sets the scale to enable only approved features per OIML R-76; Only kg weight units are available; The zero range is limited to 4% (-1 to +3% relative to calibrate zero); Net/Gross function is temporary; Once net weight is established, pushing an <b>F-key</b> set for Net/Gross will cause a maximum 5 second display of the gross weight; Clear the Tare to display gross weight constantly; Other metrological aspects are changed to meet R-76 requirements
<i>1Unit</i> (1Unit)	The 1Unit standard is exactly the same as Industrial, except units switching is inhibited; Used for metric only countries or where 1Unit standard is to allow the scale to be calibrated in units other than lb or kg, since conversions are eliminated; Contact Rice Lake for more information on the standards settings

Table 4-3. Standard Menu Selections

Use the following steps to set up standard settings.

1. Press  and  simultaneously. *Funct 1* displays.
2. Press  to scroll to *StAnd*.
3. Press . The currently saved standard displays.
4. Press  to scroll through the choices.
5. With choice displayed, press  to select. *Funct 1* displays.
6. Press  to save and exit to **Weighing** mode.

## 4.8 Remote Display Scale Setup

The MSI-8000 RF Remote Display can be used to operate several MSI crane scales (MSI-4260, MSI-3460 and MSI-7300). Some functions can also be set using the MSI-8000 RF Remote Display. The information in this section pertains to the setup of the scale being used with the remote. The scale displayed is the scale being remote configured.







Parameters	Choices	Description
Filter	OFF	Weight Filter – Allows the scale to adjust to situations where there may be movement; See <a href="#">Section 4.8.2 on page 15</a>
	LO	
	Hi-1	Hi-2 – MSI-7300 only
	Hi-2	
Total	OFF	Total Accumulation – Sets the choice for weight accumulation for a single scale ( <a href="#">Section 4.3.2 on page 9</a> ); When set to off, it's disabled
	TELOn	Total On – Is a manual choice for accumulation ( <a href="#">Section 4.3.2 on page 9</a> )
	A. Load	Auto Total – Choices for setting automatic accumulations
	A. Last	
	H. High	
SetPt 1-B	GREATER	Greater Than – Setpoint triggers when the tension exceeds the value ( <a href="#">Section 4.5 on page 12</a> )
	LESS	Less Than – Setpoint triggers when the tension is less than the value ( <a href="#">Section 4.5 on page 12</a> )
	OFF	Off – Setpoint parameter is disabled ( <a href="#">Section 4.5 on page 12</a> )
Battery Life	Standard	Battery Life – Sets the options for standard or extended battery life; See <a href="#">Section 4.6 on page 13</a>
	Long	

Table 4-4. Settings for the Scale Using the Remote

### 4.8.1 Filter Setup

The filter settings are used to stabilize the weight in an unstable condition. Increasing the filter will improve the stability, however settling times will be longer. The MSI-8000 RF Remote Display employs algorithms that speed up large weight changes while still controlling vibration with high filter settings.

Use the following steps to set up filtering.

1. Press  and  simultaneously. *FUNC 1* displays.
2. Press  to scroll to *Filter*.
3. Press . The currently saved **Total** mode displays.
4. Press  to scroll through the choices.
5. With choice displayed, press  to select. *Unit* displays.
6. Press  to save and exit to **Weighing** mode.

## 4.8.2 Total Mode

For the accumulation of multiple weighments, the Total function uses the displayed load, so gross and net readings can be added into the same total.

There are four modes of totalizing, a manual and three auto modes: *R. Load*, *R. Last*, *R. High*.

All modes require that the weight on the scale return below 0.5% (relative to full scale) of **Gross Zero** or **Net Zero** before the next weighment can be added. Applied weight must be  $\geq 1\%$  of full scale above **Gross Zero** or **Net Zero** before it can be totaled.

### Manual Total

Manual Total (*Enter*) adds a current weight to a previously accumulated value manually. To add weight to the total it must be greater than 1% of capacity and not yet totaled. This assures that a weight on the scale is only added to the total once.

1. Program a **F-key** to *Enter* (Section 4.3 on page 9).
2. With the weight to be added on the scale, press **F-Total**. The acknowledge LED blinks to indicate the weight was accepted and the **TOTAL** annunciator lights. Then the total weight displays for five seconds and the number of samples displays for two seconds.
3. Repeat [Step 1](#) and [Step 2](#) until all weight samples have been added.



**Note** *Total mode will not function while the scale is in motion, ensure is on. If the system fails to achieve stable readings, increase the filter setting or increase the size of the scale division (d) in the Init Cal procedure.*

*The F-Total functions as View Total only until the 1% threshold is exceeded to allow the addition to the total value.*

### Auto Total

This mode has three variations which are programmed in the Setup menu.

Program an **F-key** to **AUTO TOTAL**, it functions as **Auto Total On / Auto Total Off** (Section 4.3 on page 9).

Setpoint	Description
<i>R. Load</i> (Auto Load)	Ensures any settled load above the Rise Above threshold will be automatically totaled; The scale must fall below the Drop Below threshold before the next total is allowed
<i>R. Last</i> (Auto Last)	Takes the last settled weight to auto total with; The total occurs only once the scale goes below the threshold; Allows the load to be adjusted without a total occurring; Once the load is removed, the scale uses the last settled reading for total
<i>R. High</i> (Auto High)	Uses the highest settled reading; This is useful for loads that can't be removed all at once

Table 4-5. Auto Load Selections

### Set Total Mode

1. Press and simultaneously. *Func 1* displays.
2. Press to scroll to *Enter*.
3. Press . The currently saved filter mode displays.
4. Press to scroll through the choices.
5. With choice displayed, press to select. *Filter* will be displayed.
6. Press to exit setup and store the settings.

### Reset Total Load

To reset the total load to zero, press **Fx-Total** again and while the total load is being displayed, quickly press .

## 5.0 Calibration

This section provides an overview of the MSI-8000 RF Remote Display calibration instructions.

### 5.1 Calibrating a Scale/Dyna-Link 2

The MSI-8000 RF Remote Display can be used for calibrating MSI ScaleCore-based crane scales and dynamometers, including MSI-3460 Challenger 3, MSI-4260 Port-A-Weigh or MSI-7300 Dyna-Link 2.

They can be calibrated using standard precision test weights. It is required that the weight used is at least 10% of full capacity in order to achieve rated accuracy.

When adequate test weights are not available, the scale/dynalink can be calibrated using a constant calibration (C - CRL) ([Section 5.2.2 on page 18](#)).

















**Note** *If the linked scale/Dyna-Link is sealed for NTEP approval, the seal will need to be broken and the calibration switch on the linked scale/Dyna-Link will need to be pressed for the MSI-8000 RF Remote Display to perform the calibration.*

### 5.2 Initial Calibration















Initial calibration is used to setup units, capacity and resolution (d) required for the load cell.

Initial calibration is also performed after a calibration reset which deletes all calibration.

1. Press  and  simultaneously. CRL displays.
2. Press the programmed F-key to scroll to the load cell to be calibrated.
3. Press , Unit displays.
4. Press . The default units are displayed.
5. Press  to scroll through the available units.
6. With desired unit displayed, press  to select. CAP displays.
7. Press . The default capacity displays.
8. To enter a different capacity, press .
9. Press  to scroll through numbers and  to save the selected numbers.
10. When all numbers have been selected, press  to store the number. d displays.
11. Press . The default display divisions are displayed.
12. Press  to scroll through the available display divisions.
13. With desired display division displayed, press  to select. UNL d displays.
14. Proceed with the routine calibration, starting with [Step 2 of Section 5.2.1 on page 17](#).

## 5.2.1 Routine Calibration











For maintenance and routine calibration use the following steps.

1. Press the configuration switch.  $\square RL$  displays.
2. Press ,  $UnLd$  displays.
3. Remove all weight from the scale.
4. Press ,  $\square$  flashes.
5. Press ,  $PASS$  displays momentarily then  $Ld1$  displays.
6. Load the scale with a precision test weight, for best accuracy a test weight of 10% of capacity or more is recommended.
7. Press , the capacity of the scale flashes.
8. To enter a test weight other than the capacity, press .
9. Press  to scroll through numbers and  to save the selected numbers.
10. When the correct weight displays, press  to store the number. If cal value is within limits,  $PASS$  displays momentarily then  $Ld2$  displays.
11. Press  to enter the second load.
12. Add load to scale and press .
13. Press , the current weight on the scale flashes.
14. Repeat [Step 3–Step 10](#), up to four loads.
15. When all loads are complete, press  to store the calibrations.  $\square RL$  displays.
16. Press  to view the cal number.  $\square - \square RL$  flashes momentarily followed by the  $\square - \square RL$  number, record the value, this number will be required if calibrating with  $\square - \square RL$  ([Section 5.2.2 on page 18](#)).
17. Press .  $StorE$  displays momentarily, then  $SEtUP$  displays.
18. Press  to exit **Calibration**.  $StorE$  displays momentarily, then the unit returns to **Weigh** mode.
19. Repeat this procedure to calibrate all load cells connected to the MSI-8000 RF Remote Display.

## 5.2.2 C-Cal Calibration







When adequate test weights are not available, the scale can be calibrated using a cal number calibration which is referred to as C-Cal. To use C-Cal, a factory generated C-Cal number must be known. When a calibration is performed with test weights, a new C-Cal is generated.







The C-Cal number must be known prior to starting this procedure. Rice Lake prints this number on the serial number label of new scales. C-Cal reduces slightly the accuracy of the system and is intended for non-critical use only. For highest accuracy, calibrate with precision test weights.

1. Press the configuration switch. *CAL* displays.
2. Press  to scroll to *C-CAL*.
3. Press , *Unit* displays.
4. Remove all weight from the scale.
5. Press , *0* flashes and *PASS* displays momentarily. *C-CAL* displays.
6. Press , the last known *C-CAL* displays.
7. To except the number displayed press . Skip to [Step 10](#). To enter a different *C-CAL* number, press .
8. Press  to scroll through numbers and  to save the selected numbers.
9. When the correct number displays, press  to store the number. *PASS* displays momentarily then *CAL'd*.
10. Press . *STORE* displays momentarily then *SETUP* displays.
11. Press  to exit calibration. *STORE* displays momentarily, then the unit returns to **Weigh** mode.

## 5.3 Setup

Setup is used to set the desired Industry Standard and Auto Zero Maintenance (AZM).

1. Press the configuration switch ([Section 5.2 on page 16](#)). *CAL* displays.
2. Press  to scroll to *SETUP*.
3. Press , *Stand* displays.
4. Press , the current standard setting displays.
5. Press  to scroll through calibration standards selections. See [Section 5.3.1 on page 19](#) for standards details.
6. When desired option displays press . *AUTO* displays.
7. Press  to enter Auto Zero Maintenance.
8. Press  to toggle between *ON/OFF*.



9. Press  to set on or off.  $\square$ .  $P-UP$  displays.
10. Press  to enter zero on power-up.
11. Press  to toggle between  $\square$ / $OFF$ .
12. Press  to set on or off.  $StAnd$  displays.
13. Press  to return to  $cRL$ .
14. Press  again to exit calibration.  $StOrE$  displays momentarily, then the unit returns to **Weigh** mode.

### 5.3.1 Standard Settings

See [Section 4.7 on page 13](#) for **Standard** menu settings.

## 5.4 Reset the Load Cell Calibration

To completely remove current calibration, a calibration reset must be performed.

1. Press the F-key set to scan to scroll to load cell to reset.
2. Press and hold the calibration switch, then press .  $rESEt$  flashes.**ss**
3. Press ,  $SUR-E$  flashes.
4. Press  to reset the calibration for current load cell.  $cRL$  displays.
5. Proceed with the Initial Calibration ([Section 5.2 on page 16](#)).

#### IMPORTANT

Pressing  to reset all indicator settings to the original factory settings.



**Note** Press  to cancel reset and return to the previous menu.

## 6.0 Communications

This section provides an overview of the MSI-8000 RF Remote Display communication instructions.

### 6.1 Communications Setup

The MSI-8000 RF Remote Display uses 802.15.4 transceivers to communicate.

802.15.4 operates in the 2.4 GHz systems if:

- Antennas are isolated at least 10' (3 m) from the equipment
- MSI-8000 based RF systems are peer to peer; For multiple scale connections, the MSI-8000 acts as the network coordinator

The MSI-8000 RF Remote Display uses three numbers to establish a piconet. A piconet is a network that is created using a wireless Bluetooth connection. [Table 6-1](#) lists out the three elements used in setting up a piconet. The ID is recommended to be in the range of 20–30.

Name	Description	Recommended Number Range
ScaleCore ID	Used to identify each device in a piconet, its range is 0–254 and cannot be duplicated within the same RF channel	20–30
RF Channel	Establishes the base network that all interconnected devices must match	12–23
Network ID	A 64-bit number that all interconnected devices must match, do not use a small number to avoid other 802.15.4 transceivers that default to a network ID of 0	Maximum of six digits with a range of 0–99999

**NOTE:** For all devices that must interconnect, the RF channel and network ID must match. The ScaleCore ID must be unique. The Dyna-Link or crane scale that is the weight source should be set to a ScaleCore ID of 0. If other source devices are added, they can be added in sequence.

Table 6-1. Piconet Setup Ranges

### 6.2 Communications Menu

To enter the **Communications** menu, press  and  at the same time. *busy* flashes momentarily before entering the **Communications** menu.

Parameters	Choices	Description
<i>Print</i>	--	Print – Prints a ticket if connected to a printer ( <a href="#">Section 6.2.1</a> )
<i>rF</i>	--	Radio Frequency ( <a href="#">Section 6.2.2 on page 23</a> )
<i>cF.nEt</i>	<i>tl.o.rd</i>	Load Totaling – The total number of Remote Sensor Devices (RD's) – Range 1–4 (Default is 1) ( <a href="#">Section 6.2.3 on page 24</a> )
	<i>ttl.rd</i>	Total Remote Displays All – Sum of all remote devices Prirs – Sum in pairs (requires four remotes) both – Sum in pairs plus grand total vsedef – Programmed using a computer program such as Scope off – Summing is disabled
	<i>l1st id</i>	--
	<i>Sc id</i>	ScaleCore ID – Number must match ( <a href="#">Section 6.2.4 on page 26</a> )
	<i>Sn id</i>	Sensor ID

Table 6-2. Communications Menu Parameters

#### 6.2.1 Printer Setup

The RS-232 communications port is capable of outputting load data. RF linked weight device weight modes are available in user formatted form. The **Control** mode program is what controls the MSI-8000 RF Remote Display to print and is described in [Section 6.2.1.3 on page 22](#). The communications port settings are independent of any print settings in connected scales.











Choices	Description
<i>l1stnr</i>	Print Setup – Select the channel the port will be used with; Options: 0, 1, 2
<i>DUtPUt</i>	Port Selection – Select the port to use for communication with the printer; Options <i>Port 0</i> , <i>rF</i> , <i>Port 2</i> ( <a href="#">Section 6.2.1.1 on page 21</a> )
<i>Strng</i>	String Setup – Print string format number entry screen ( <a href="#">Section 6.2.1.2 on page 22</a> )
<i>Ctrl</i>	Print Control Options – <i>USEr</i> , <i>LoAd</i> , <i>Cont</i> , <i>OFF</i> ( <a href="#">Section 6.2.1.3 on page 22</a> )
<i>rPtE</i>	Output Rate – Print string output rate number entry screen (0–65536 seconds)

Table 6-3. Print Setup Parameters















### 6.2.1.1 Printer Output Setup

Use the following steps to set up the printer output.

1. Press  and  at the same time. *Print* displays.
2. Press . *Listnr* displays.
3. Press  to scroll to *Strnc*.
4. Press . The current print string number is blinking.
5. Press  to scroll through the numbers and press  to save and move to the next number.  
*Example: If Net, Gross and Tare are to be used for the print format, the entry required would be 2349. The 2 is net, 3 is Gross, 4 is tare and 9 inserts a space before the next print output.*
6. Once all numbers are set, press  to save the **Print** mode. *Print* displays.
7. Press . The current **Control** mode displays.
8. Press  to scroll through the options.
9. When the desired **Control** mode displays, press . *Rate* displays.



**Note** If **Control mode has been set to continuous**, press  then skip to [Step 13](#).

10. Press . The current print rate displays.
11. Press  to scroll through the numbers and press  to save and move to the next number.
12. When number is correct, press . *Listnr* displays.
13. Press . The current listener value displays.
14. Press  to scroll through the numbers and press  to save and move to the next number.
15. Once the desired value displays, press  to save. *Output* displays.
16. Press . The current output displays.
17. Press  to scroll through the options.
18. Once the desired output displays, press  to save. *Strnc* displays.
19. Press  three times to exit, *StorE* displays briefly, then the unit returns to **Weigh** mode.

### 6.2.1.2 Standard Print Strings

Commands that can be used to format gross, net and print strings are shown below.

Command	Description
<T>	Load data
<U>	Units
<M>	Load mode (lb/kg)
<CRLF>	Carriage return line feed
<SP>	Space

Table 6-4. Standard Print Strings

Load	Parameter	Description
1	Current load	Fixed output length: 16; Leading zeros suppressed except for the least significant digit (LSD) <TTTTTT><SP><UU><SP><MMMMM><CRLF>
2	Net load	Fixed output length:16; Leading zeros suppressed except for the LSD <TTTTTT><SP><UU><SP>NET<SP><SP><CRLF>
3	Gross load	Fixed output length: 16; Leading zeros suppressed except for the LSD <TTTTTT><SP><UU><SP>GROSS<CRLF>
4	Tare Weight	Fixed output length: 16; Leading zeros suppressed except for the LSD <TTTTTT><SP><UU><SP>TARE<CRLF>
5	Total Weight	Fixed output length: 16; Leading zeros suppressed except for the LSD <TTTTTT><SP><UU><SP>TTL<CRLF>
6	Number of Samples Totaled	Fixed output length: 16; Leading zeros suppressed except for the LSD <SP><SP><SP><SP><SP><SP><SSSSSS><SP><T-CNT><SP><CRLF>
7	Current Weight Mode	Net, Gross, Peak and other parameters <SP><MMMMM><CRLF>
8/9	Carriage Return/Line Feed	Used to add a space between print records <CRLF>

Table 6-5. Standard Print Strings

Combinations of the standard print strings can be entered in the string number entry screen.

*Example: To get a Net, Gross, Tare printout with a space between records, enter 2349.*

The ScaleCore Connect application can also be used for custom output strings.

ScaleCore Connect application is available at: [www.ricelake.com](http://www.ricelake.com).

The serial output is configured as 9600 baud, Xon/Xoff handshaking, no hardware handshaking, 1 stop bit, no parity.

Other baud rates are possible by special order only.

### 6.2.1.3 Control Modes

The user can select four **Control** modes. The **Control** modes are described in [Table 6-6](#).

Mode	Description
User	Printing is controlled by pressing the <b>F3</b> key
Load	One print occurs when a stable load is read, the scale must then return to near zero before another print will occur <b>NOTE: Other configurations of load are available using the ScaleCore Connect application.</b>
Continuous	The unit will continuously output the data at a rate specified in the rate parameter (up to 65,535 seconds); Setting the interval to 0 will set an interval as fast as the system can go
Off	Printing is disabled; Power consumption is lower with the print off

Table 6-6. Control Modes

### 6.2.2 RF Setup

Allows the setup of the Radio Frequency.

Mode	Description
On OFF	Enable RF – On/Off, affects continuous mode only
Scale ID	ScaleCore ID – Range 1–254, (20–30)
Channel	RF Channel – Range 12–23
Network ID	Network ID – Range 0–999999
Transmission Strength	Transmission Strength – Range 0–4 (Table 6-8)
TYPE	Allows the selection of radio card that is being used; For cards other than ZXee us the other selection: DETER, ZBEE
Hold	When set to On, the radio continues to use power; This will use the battery power faster; Default is set to OFF

Table 6-7. RF Setup Parameters



**Transmission strength should be set to the lowest setting possible to achieve the transmission required. Both scale/Dyna-Link and MSI-8000 RF Remote Display should be set at the same transmission strength setting.**

Setting	RF Power Level	Transmit Current	Note
0	10 dBm	137 mA	Lowest Transmission Power
1	12 dBm	155 mA	Default on Dyna-Links and MSI-8000 RF Remote Display
2	14 dBm	170 mA	—
3	16 dBm	188 mA	—
4	18 dBm	215 mA	—

Table 6-8. Transmission Strength Settings



Use the following steps to set up the **RF** menu parameters.

- Press **F1** and **F3** at the same time, **PRINT** displays.
- Press **F2** to scroll to **RF**.
- Press **F1**. **On OFF** displays.
- Press **F1**. The currently saved parameter displays.
- Press **F2** to toggle between on and off.
- With **On** displayed, press **F1** to select. **OFF** is used when the 8000 is hardwired to a Dyna-Link. **Scale ID** displays.
- Press **F1**. The current ScaleCore ID displays.
- Press **F2** to scroll through numbers and **F1** to save the selected numbers.
- When number is correct, press **F1** to store the number. **Channel** displays.
- Press **F1**. The current channel setting displays.
- Press **F2** to scroll through numbers and **F1** to save the selected numbers.
- When number is correct, press **F1** to store the number. **Network ID** displays.

13. Press **F1**. The current Network ID displays.
14. Press **F2** to scroll through numbers and **F1** to save the selected numbers.



**Note** *Rice Lake Weighing Systems recommends at least a four digit for the Network ID, to ensure there are no conflicts with any other 802.15.4 networks.*

15. When number is correct, press **F1** to store the number. *5-E-N* displays.
16. Press **F1**. The current **Strength** setting displays.
17. Press **F2** to scroll through 0–4.
18. When the number is correct, press **F1**. *TYPE* displays.
19. Press **F1**. The current type displays.
20. Press **F2** to scroll through values.
21. With selected value displayed, press **F1**. *Hold* displays.
22. Press **F1**. The current setting displays.
23. Press **F2** to toggle between on and off.
24. When the selection is correct, press **F1** to store the number. *On OFF* displays.
25. Press  to save and exit the **RF** menu.
26. Press  to exit to the **Communication** menu.

### 6.2.3 Setup Multiple Sensor Network

The MSI-8000 RF Remote Display can monitor up to four load sensors. The sensors can be read individually, in pairs or summed. Dyna-Link 2 is shown for illustration purposes only. The Challenger 3 or Port-A-Weigh can also be used.

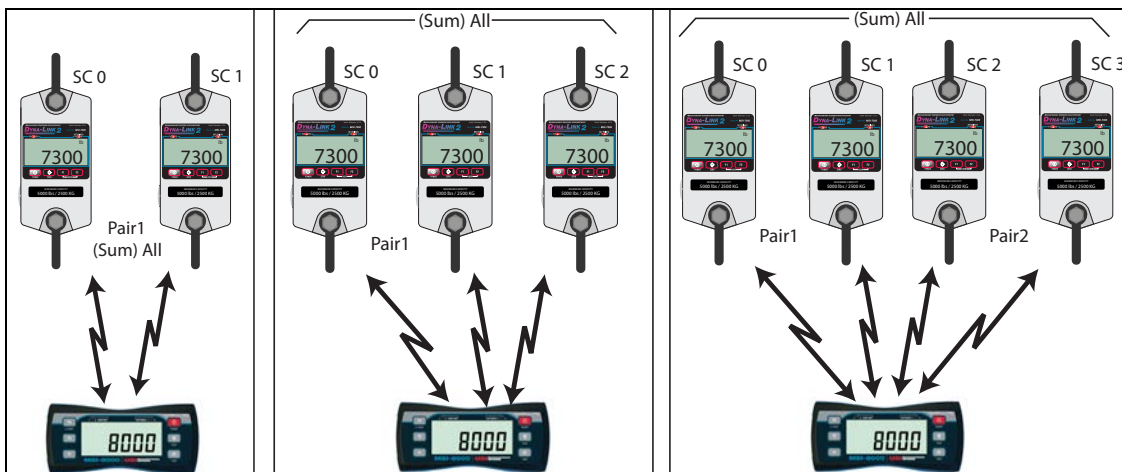



















Figure 6-1. Multiple Sensor Network

Each sensor has a unique ScaleCore ID (SCID). The IDs must be consecutive, starting with 0. This is set in the sensor setup, not in the MSI-8000 RF Remote Display. See the Dyna-Link 2 Technical Manual (PN 152160).

### 6.2.3.1 Set the Total Number of Load Cells

1. Press  and  at the same time. *Prnt* displays.
2. Press  to scroll to *cF.nEt*.
3. Press  *tΠa.Ld* displays.
4. Press . The **Load Totaling** setting displays.
5. Press  to scroll through numbers and  to save the selected numbers.
6. When correct number of scales/Dyna-Link 2 attached (2-4) displays, press . This number does not include the MSI-8000 RF Remote Display or any modems. *tEtL.rd* displays.
7. Press . The **Load Totaling** setting displays.
8. Press  to scroll through numbers and  to save the selected numbers.
9. Press . *tNo rd* displays.
10. Press  twice to exit to the **Weighing** mode.

### 6.2.3.2 Scan Weight Inputs

1. Program  to the *ScFn* function, and  to the *Add.Ld* function for summed sensor readings (Section 6.2.3.3).
2. The current channel displays, press  to change to the next channel. The scan channel number displays briefly, then the scan channel weight displays.
3. Press . In a two sensor system the scan returns to the first channel (0).

### 6.2.3.3 Load Totaling Settings

There are four different types of load totaling modes and are explained below.

#### All

All channels are added together, press **Fx-Add.Ld** to view the sum of all sensors connected. Pressing **Fx-Add.Ld** again confirms that the summed channels are being displayed, by briefly displaying *Add.Ld* (total remote sensor devices).



**Note** *If the sum is the only thing to be observed, disable the Scan function key using the Function Key Setup menu (Section 4.3 on page 9).*

#### Pairs

Used with four sensor systems, scrolling through the channels with **Fx-Add.Ld**, they will be presented as separate weights first and then as pairs. This display is preceded by the LCD message *PR r1* and *PR r2*.

#### Both

This mode displays both the pair totals and the overall total. Each press of **Fx-Add.Ld** scrolls through the summed combinations. First *PR r1*, then *PR r2* then the sum of all connected sensors displays.

#### Off

Sensor summing disabled. A function key set to *tEtL.rd* is unnecessary.

1. Program an **F-key** to the *tEtL.rd* function (Section 4.3 on page 9). The current channel displays.
2. Press **Fx-ttl.rd**. **Ad.All** displays briefly, then the summed total.
3. Continue pressing **Fx-ttl.rd** to view all enabled sum types.

## 6.2.4 Scan List ID

The scan list ID specifies the load cell/sensor that scale one through four will use for summing totals. It allows up to four devices to be summed together on the remote display.

1. Press **F1** and **F3** at the same time. *Print* displays.
2. Press **F2** to scroll to *Scale*.
3. Press **F1**. *List* displays.
4. Press **F1**. Current *List* flashes.
5. Set the ID number of the LC/Sensor that will be assigned to Scale.1 (0-3 are used to represent 1-4. For example, 0=1, 1=2, 2=3, 3=4).
6. Press **F1** to store the number. *Scale* displays.
7. Press **F1**. The scale ID must match the ID of the LC/Sensor being connected to.
8. Press **F1** to store the number. *Scale* displays.
9. Press **F1**, The sensor number is used to select a LC connect to the Scale being addressed in *List*.
10. Press **F1** to store the number. *List* displays.
11. Press **F1** twice to exit to the **Weighing** mode.

The sum will now reflect the total of all LC/Sensors specified.

## 6.3 Communications Port Hardware

The MSI-8000 RF Remote Display RS-232 communication port is used for software updates, connecting to a remote display and for connecting to any RS-232 device.

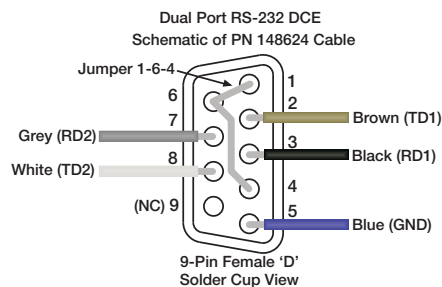

Figure 6-2. Standard Adapter Cable (PN 148624)

**Connector** – M12 industrial IP67 rated. An adapter cable (PN 150964) is required to connect the MSI-8000 RF Remote Display to a computer. This adapter cable converts the 8000 connector to a standard D9 serial connector. The 503489 cable can be converted to DTE by using a Null Modem adapter.

**Data Configuration** – The data output is fixed at 8-1-N.

**Baud Rate** – Programmable for 300 to 230.4 k baud in 8 steps. The bootloader for updating software is always 38.4 k baud

**Handshaking** – No hardware handshaking is supported. Xon/Xoff software handshaking is always on. This configuration plugged into a standard DTE connector disables comm port 2. Turn comm port 2 off using the **Comm Port** menu.

An unterminated cable is available (PN 143348) for wiring a connector to the M12 connector found on the MSI-8000 RF Remote Display.

The following diagrams show how to wire standard D9 connectors to access Communications Port 1 or Communications Port 2:

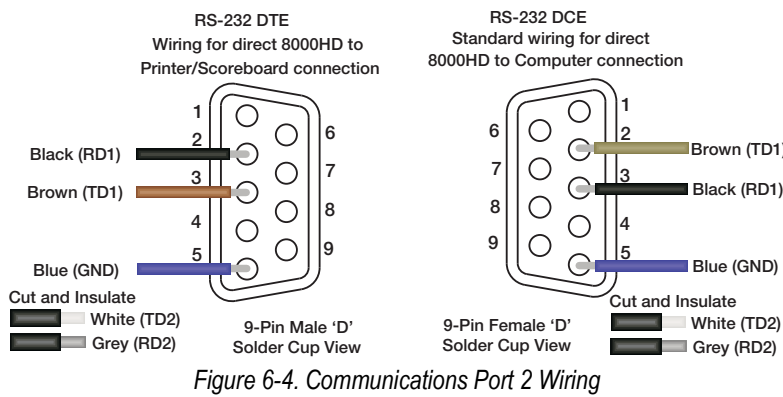
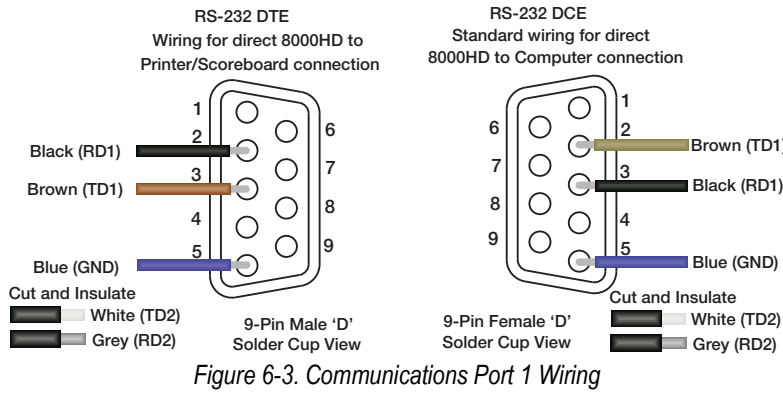

Wiring the shield drain to the metal shell of the connector is recommended, however, in some circumstances it may be necessary to disconnect the shield drain wire at the connector frame to prevent ground loops which can cause unstable readings. In extreme cases it may be necessary to use an isolated RS-232 interface.

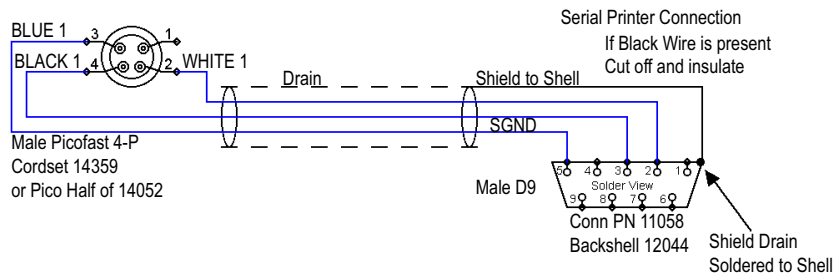
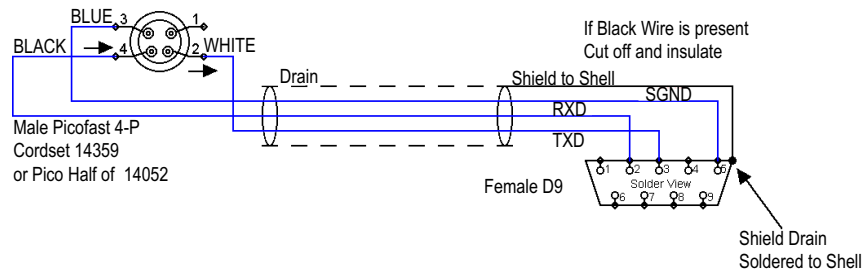

## 6.4 Relays

The MSI-8000 RF Remote Display can be equipped with up to two relays for process control or safety systems.

Two independent relays are factory installed and are wired out to 4 pins on a M12 connector.

The connecting cables are shown in the table below:

Part No.	Description
144440	PVC 4 m, rated to 250 VRMS, 4 A
	PVC 10 m, rated to 250 VRMS, 4 A
Alternately use a field wireable connector	
156256	Straight for cable 4–6 mm OD
	Right angle for 4–6 mm
	Straight for cable 6–8 mm OD
	Right angle 6–8 mm OD

Table 6-9. Relay Connector Cable Part Numbers

### 6.4.1 Relay Options

Relays are normally open (1 Form A). Specifications are listed below:

Relay Type	Description
AC/DC coil relay	AC/DC Coil Relay: 144520 PA1a-5V. 4 A Fuse: 144307 AC Rating: 250 VAC at 4 A (limited by connector/cordset rating to 4 A continuous) DC Rating: 4 A at 30 VDC, 0.4 A at 100 VDC Best choice for 90% of applications
AC/DC SSR (solid state relay) - 60 V	Better for battery powered units and mates well with 24 VDC industrial power supplies AC/DC SSR 60 VPK, 2.7 A: 13178 AQZ202D. 2 A Fuse: 144319
AC/DC SSR - 120 V	For 115 VAC operation when SSRs are preferred; AC/DC SSR 200 VPK, 0.9 A: 13180 AQZ207D. 0.75 A Fuse: 155221
Other available relays	AC/DC SSR 100 VPK, 2 A: 13179 AQZ205D. 1.5 A Fuse: 155220 AC/DC SSR 400 VPK, 0.45 A: 13181 AQZ204D. 0.375 A Fuse: 155222 (use limited to 250 VRMS due to connector and cordset limitations) DC Only SSRs DC SSR 60 VPK, 4 A: 13182 AQZ102D. 3 A Fuse: 155223 DC SSR 200 VPK, 1.3 A: 14566 AQZ107D. 1 A Fuse: 160448 <b>NOTE: Normally open relays (1 Form A) can be made to function as normally closed (1 Form B) by programming the setpoint as a less than type. If the MSI-8000 RF Remote Display is turned off or loses power, the relays will open.</b>
One 1 Form B closed SSR	AC/DC SSR 400 VPK, 0.5 A: 14628 AQZ404. 0.5 A Fuse 144583 (use limited to 250 VRMS due to connector and cordset limitations); See Figure 6-7 for information about cordset or Field Wireable Connector; Requires a minor modification on the Relay board and can only be ordered by contacting Rice Lake Weighing Systems

Table 6-10. Relay Options

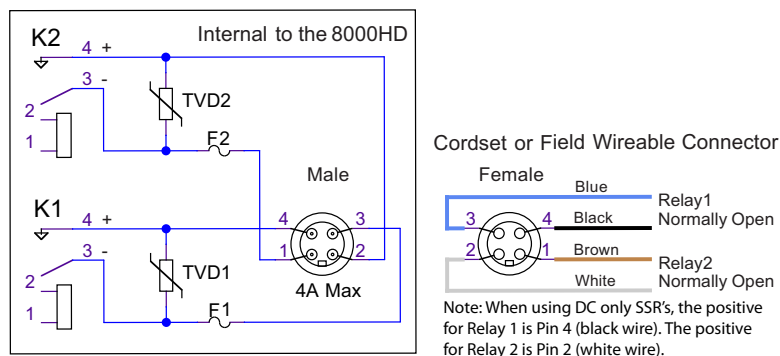

Figure 6-7. Cordset or Field Wireable Connector



## 6.5 Radio Compliance

All radio options meet FCC and international radio compliance per the certification information listed in this section. These modules may have additional international certifications that are not listed in this section. Please contact Rice Lake Weighing Systems if you require operation in a jurisdiction that is not listed.

### 6.5.1 802.15.4

#### FCC Statement

Contains FCC ID: MCQ-PS2CTH

The MSI-8000 complies with Part 15 of the FCC Rules. Operation is subject to the following conditions:

- This device may not cause harmful interference
- This device must accept any interference received, including interference that may cause undesired operation

#### International Certifications

**Canada:** Radio Certificate Number: IC 1846A-PS2CTH

**Australia & New Zealand:** DIGI-090F15C247

### 6.5.2 Wi-Fi

#### FCC Statement

Contains FCC ID: T9J-RN171

The MSI-8000 complies with Part 15 of the FCC Rules. Operation is subject to the following conditions:

- This device may not cause harmful interference
- This device must accept any interference received, including interference that may cause undesired operation

#### International Certifications

**Canada:** Radio Certificate Number: IC 6514A-RN171

**Korea:** Radio Certificate Number: KCC-CRI-029-RN-171

#### Europe:

The product is compliant with the following standards and/or other normative documents:

- EN 300 328: V1.8.1 (2012)

The product is compliant with the following standards and/or other normative documents:

- Safety (article 3.1A) EN 60950-1:2006+A11:2009+A1:2010+A12:2011
- EMC (article 3.1b) EN 301 489-1 : V1.9.2 (2011) In accordance with the specific requirements of ETSI EN 301 489-17: V2.2.1 (2012)

### 6.5.3 Bluetooth

#### FCC Statement

Contains FCC ID: T9J-R41-1

The MSI-8000 complies with Part 15 of the FCC Rules. Operation is subject to the following conditions:

- This device may not cause harmful interference
- This device must accept any interference received, including interference that may cause undesired operation

#### International Certifications

**Canada:** Radio Certificate Number: IC 6514A-RN411

#### Europe:

The product is compliant with the following standards and/or other normative documents:

- EN 300 328-1
- EN 300 328-2 2.4GHz

### 6.5.4 FHSS (Frequency Hopper Spread Spectrum)

#### FCC Statement

Contains FCC ID: HSW-DNT24

The MSI-8000 complies with Part 15 of the FCC Rules. Operation is subject to the following conditions:

- This device may not cause harmful interference
- This device must accept any interference received, including interference that may cause undesired operation

#### International Certifications

**Canada:** Radio Certificate Number: IC 4492A-DNT24

#### ETSI Certified

## 7.0 Troubleshooting

This section provides an overview of the MSI-8000 RF Remote Display troubleshooting and maintenance instructions.



Problem	Possible Cause	Solution
The display is blank when the power key is pressed	Discharged battery	Recharge the battery
	Defective battery	Replace the battery (factory replacement only)
	Defective switch or circuit board	Requires authorized service
The display does not function properly/front panel keys do not function normally/scale/Dyna-Link will not turn off	Improperly loaded software	Reinstall the software
	Faulty circuit board	Requires authorized service
	Loose connectors	Requires authorized service
Scale/Dyna-Link does not respond to tension changes	Out of calibration	Calibrate the unit
	Faulty load cell	Replace the load cell
	Load cell connector	Check connectors and wires
The display over ranges below 100% of capacity	Tared tension is added to load to determine overload point	Return to gross tension mode
	Zero requires adjustment	Rezero the scale
	Too much tension/load has been zeroed	Rezero the scale
The display drifts	AZM (Auto 0) is turned off	Turn AZM on
	Rapid temperature changes such as moving the scale from indoors to outdoors	Wait until the scale temperature has stabilized
Displayed tension shows a large error	Scale not zeroed before load is lifted	Zero the scale with no load attached
	lb/kg units causing confusion	Select proper units
	Requires recalibration	Recalibrate the unit
The display reading is not stable	Excessive vibration	Increase filtering or increase <b>d</b> in Cal
	Excessive side loading	Improve load train symmetry
	Load cell faulty	Check load cell connections
The display toggles between <b>Error</b> and <b>Load</b>	Load exceeds capacity	Reduce tension immediately
	Faulty load cell or wiring	Check load cell and load cell wiring
The display toggles between <b>Error</b> and <b>Button</b>	A key is stuck or is being held down	Check switches for damage
Weight is on the scale/Dyna-Link and RF Remote Display does not match	Units are not paired	See setting the RF Network address procedures
<b>Lo Batt</b> is blinking	The battery is low	Recharge the battery
The unit turns on, then immediately off	The battery is low	Recharge the battery
The load will not zero	The system not stable	Wait for stable symbol  to turn on Increase filtering for more stability
	Zero out of range	Zero range might be limited; Reduce the tension or use Tare instead
The load will not tare or total	The system not stable	Wait for the stable symbol  to turn on, or if in a noisy mechanical crane, increase the filtering or reduce the size of the scale increment d; It is also possible to increase the motion window; Contact Rice Lake Weighing Systems if there is a problem getting the unit to zero, tare or total due to issues
Setpoint lights blink	Set point is enabled and the trigger point has been reached	Disable set points if they are not needed
The manual total does not work	A function key is not set to <b>total</b>	Set up Func1 or Func2 for <b>total</b>
	Tension must be stable	Increase filtering for more stability
The auto total does not work	Load must be stable	Wait for stable symbol  to turn on or increase filtering for more stability
	Load thresholds are not reached	Weight must exceed 1% of capacity for auto total to work; Weight must drop below 0.5% of capacity for additional weightings to register

Table 7-1. Troubleshooting Solutions

## 7.1 Error Codes

The MSI-8000 RF Remote Display ScaleCore processor detects errors and generates error codes to aid in troubleshooting.



Error Code	Definition	Comment
LCOFF	LC Disabled	A Load cell was not enabled
2CAL	In Cal	The system is in calibration mode; Do not send commands unrelated to calibration
UnCAL	Not Calibrated	System has not been calibrated
 Error LoAd	Overload	Tension/Weight exceeds set capacity +9 d or load cell is damaged or disconnected
 Error UndLd	Underloaded	Tension/weight is more than 20% negative or load cell is damaged or disconnected

Table 7-2. Error Codes

## 7.2 Service Counters

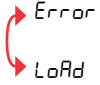

**Service Counters are important safety warning features for the MSI Brand of Rice Lake Weighing Systems and can only be reset at the factory by personnel from MSI. As part of the reset process, the service technician will perform a thorough load train inspection to ensure user safety and confirm that the product is ready to be returned for regular service.**

**See Crane Scale Safety and Periodic Maintenance Manual (PN 153105) for proper loading techniques to improve the safety and longevity of your MSI Overhead Weighing Product.**

All Rice Lake RF linked scales/Dyna-Link 2 maintain two service counters for safety.

- The LFCnt (first counter) counts lifts above 25% of capacity
- The OLCnt (second counter) counts the number of times the RF linked scale has been overloaded

These counters warn the user to inspect the load train after a number of overloads or a long term frequency of high capacity lifts. Power up will be interrupted when the lift counter exceeds 16383 lifts or the overload counter exceeds 1023 overloads. Inspect the load train then push any key to continue operation.

This feature is only available on MSI scales and RF transmitters connected directly to a load cell(s).

### 7.3 Mechanical Dimensions



Figure 7-1. Mechanical Dimensions

### 7.4 Firmware Update Procedure

Updating firmware in the MSI-8000 RF Remote Display requires the following: a DCE serial cable (MSI 503489-0001, or build per DCE cable schematic on page 28), a PC with a terminal program ("Teraterm Pro" recommended), and if the PC does not have standard RS-232 serial ports, then a USB to serial converter. Make sure the driver for the USB converter is properly installed, and that the Terminal program is set up for the proper comm port.

The latest firmware code is available from the MSI Service Department and can be emailed on request. The firmware version displays when the MSI-8000 RF Remote Display is turned on in form "01-04" (version may vary). MSI-8000 RF Remote Display firmware updates do not require a recalibration of the connected scale. Consult the version release notes for information regarding the updated code.

1. Setup the terminal serial port to 8 data bits, No Parity, 1 stop bit, 9600 BAUD, XON/XOFF (flow control).
2. Connect to the Dyna-Link serial port using the DCE cable. Connect the D9 connector to your PC or USB adapter.
3. (Optional) Test that you have a connection by typing {00FF01?}. If the connection is good the MSI-8000 RF Remote Display will respond with {000001r2;0;01E02;2011-07-08;11:05} or something similar.
4. On the terminal keyboard, type {ffff09=0199}.

- Change the terminal serial port to 38400 BAUD. Hit the 'r' key to refresh the display.  
The following menu should appear:  
MSI-8000 RF Remote Display SCALECORE2 BOOT LOADER Ver. 00-05 (c) 2012-05-02 10:55
  - (u) Download and program application code (bootloader version may vary)
  - (q) Query app code info
  - (g) Execute app code
  - (r) Refresh



**Note** *The bootloader version may vary.*

- Type **u**.  
Terminal should display:

Send File NOW, or press ^ to abort:

- Send the .prg file using the file send feature of your terminal program. The character “#” will tick away as the ScaleCore programs.

Send File NOW, or press ^to abort: #####

#####  
#####  
#####

Completed

- After file is received terminal should display “Completed.” Then the boot menu appears again.

MSI-8000 SCALECORE2 BOOT LOADER Ver. 00-05 (c) 2012-05-02 17:06

- (u) Download and program application code (bootloader version may vary)
- (q) Query app code info
- (g) Execute app code
- (r) Refresh

- Optional step: send **q** to check the program. The ScaleCore will respond with a message that details the 32b checksum, the product ID and version, and the Application Code version number in the following form:

Computed Signature 76F481D8      **32b CRC must match (76F481D8 is an example only)**  
 Received Signature 76F481D8  
 Product ID 07   MSI-8000 product family  
 Product Version ID 00   Optional features code  
 App Code Version 01-04   Firmware version number



If the CRC Signature does not match, go back to [Step 2 on page 32](#) and try again.

- Send an “r” to restore the boot menu.  
MSI-8000 SCALECORE2 BOOT LOADER Ver. 00-05 (c) 2012-05-02 10:55
  - (u) Download and program application code (bootloader version may vary)
  - (q) Query app code info
  - (g) Execute app code
  - (r) Refresh

- Send a “g.” The MSI-8000 RF Remote Display should start.

## 7.5 Reset the Remote Control

Resetting the unit will change all settings back to the default factory settings.

- Press the calibration switch and  simultaneously. *SLEEP* displays.
- Press  to reset the current indicator settings to the default factory settings. *CRL* displays.
- An initial calibration will need to be performed on the current load cell ([Section 5.2 on page 16](#)).

**IMPORTANT**

Pressing  will reset only the current load cell calibration settings ([Section 5.4 on page 19](#)).



**Note** Press the  to cancel reset and return to the previous menu.

## 8.0 Specifications

---

### Enclosure

IP65

### Keypad

On/Off, Zero (100%), Tare, Print, and two user defined keys for the following functions: peak hold, high resolution, total, view total, net/gross, units switching

### Display

6-digit 1" (25 mm) LCD

### Units Displayed

Pounds, kilograms, tons, metric tons, kilonewtons

### Annunciators

Stable, COZ, low battery, peak, kg, kN, lb, M, ton, setpoint, function LEDs

### Power

Internal lithium ion battery

Universal 115/230 VAC, 50/60 Hz battery charger

NA or EU plug included

### Operating Time

Up to 24 hours of continuous use (15 minute auto-shutoff with non-use)

### Operating Temperature

Legal and Industrial -4°F – 140°F (-20°C – 60°C)

Rated Accuracy Range 14°F – 104°F (-10°C – 40°C)

NTEP 14°F – 104°F (-10°C – 40°C)

### Enclosure

IP65 with charger port plug installed

### Calibration

No Calibration parameters are stored in the MSI-8000 RF Remote Display; It can be used to calibrate an RF connected scale

### Auto-Off Mode

Prolongs battery life by turning the power off after 15, 30, 45 or 60 minutes (operator determined) of no weight activity

### Units

kg, lb, tons (US short ton), metric tons, kilonewtons (other units available with custom calibrations);

Available units are determined by the RF Linked scale

### Totalization

Standard: press key or automatic; Total weight up to 999999 X 1000 units

### Set Points

Two internal set points and two ultrabright LEDs on indicator panel

### RF Radio Link

2.4 GHz 802.15.4

### RF Effective Range

Typically < 100' (33 m)

### Data I/O

RS-232 comm port

### Warranty

One-year limited





© Rice Lake Weighing Systems Specifications subject to change without notice.  
Rice Lake Weighing Systems is an ISO 9001 registered company.

230 W. Coleman St. • Rice Lake, WI 54868 • USA

U.S. 800-472-6703 • Canada/Mexico 800-321-6703 • International 715-234-9171 • Europe +31 (0)26 472 1319